

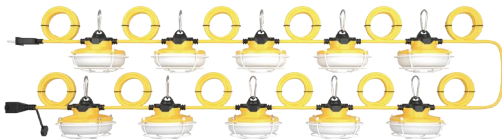

**ROMANSO**

**2025** Work Light Catalog

LIGHTING THE BUSINESSES OF TOMORROW TODAY!



**ROMANSO**<sup>®</sup>  
SINCE 2007

## Our Vision

### Lighting the Businesses of Tomorrow Today!

Romanso was founded in 2007, and is a professional manufacturer with ISO9001:2015 approval and specializing in industrial and outdoor LED lighting products. And the production area is around 60,000 sq.ft and with over 110 staff. We're customer and market oriented, and keep upgrading the high efficiency LED lights with the latest LED technology. With the great warranty policy and after-sales services, we won a high reputation from our esteemed customers and satisfied them much. In 2023, Romanso set up a new branch factory in Cambodia. The total land area occupied by the facility land size is 130,000 sq.ft. The Cambodia branch is ISO-verified factory with 200 workers, all production procedures are according to Iso9001 quality standards, the defective rate is <0.3%.



Shenzhen Headquarters

## Our Product

Romanso products are with industry-leading warranties and customer support. Main products are certificated by UL/cUL/ETL/cETL/TUV/SAA/FCC/CE/RoHS and most listed by DesignLights Consortium® (DLC). Romanso owns an experienced professional R&D engineering team who commitment to develop more new products to satisfy market demand and keep launching 2 to 3 new series every year. Newest testing equipment ensure products development and stability, including integrating sphere test, IES photoelectricity test, salt spray test, high and low temperature test, aging test, voltage surge test, withstand voltage test, insulation resistance tester, waterproof test and so on.



Shenzhen Factory

## Our Capacity

Romanso throughout the whole processes of design, mould production, parts production, SMT production, assembly production and sales of finished led lighting products in house. Romanso owns mature production lines, equipped with die-casting machines, CNC machines, coating machines, painting machines, SMT machines, reflow soldering machines, drilling machine, bench grinder, ultrasonic machine, injection molding machine, glue potting machine, oven, laser machine, aging racks, automatic packing machines in the factory. Monthly production capacity can reach 120,000pcs LED fixtures.



Cambodian Factory

(equipped with die-casting workshop, SMT workshop, testing machines in house)



Front Desk



SMT Workshop

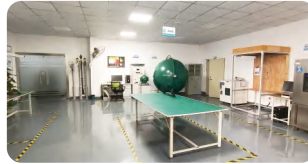

UL Authorized Laboratory



Showroom

## Company Patents and Certifications



# LED LOADING DOCK LIGHT SERIES

ROMANSO LED dock lights provide light into trailers during the loading and unloading process with a high-visibility beam of light attached to an adjustable arm. This light creates a productive, safe and OSHA compliant working environment. Illuminating trailers with bright, long lasting and energy efficient lighting on a heavy-duty design, made for applications that are susceptible to wear and damage. It delivers lower energy cost with high quality superior light over incandescent, quartz or metal halide technologies traditionally used in loading dock applications.



**RMS-L2402**  
**SPECIFICATIONS**



Item NO.	Watt	Total Lumens	Beam Angle	LED Brand	CCT	Input Voltage	CRI	Power Factor	IPRating
RMS-L240220	20W	2600lm	30°	EPISTAR	3000K	100-277V/120V with plug, 50-60Hz	≥80	>0.9	IP65
RMS-L240230	30W	3900lm			4000K				
RMS-L240250	50W	6500lm			5000K 5700K 6500K				

Remarks: All lumen specs are based on 5000K

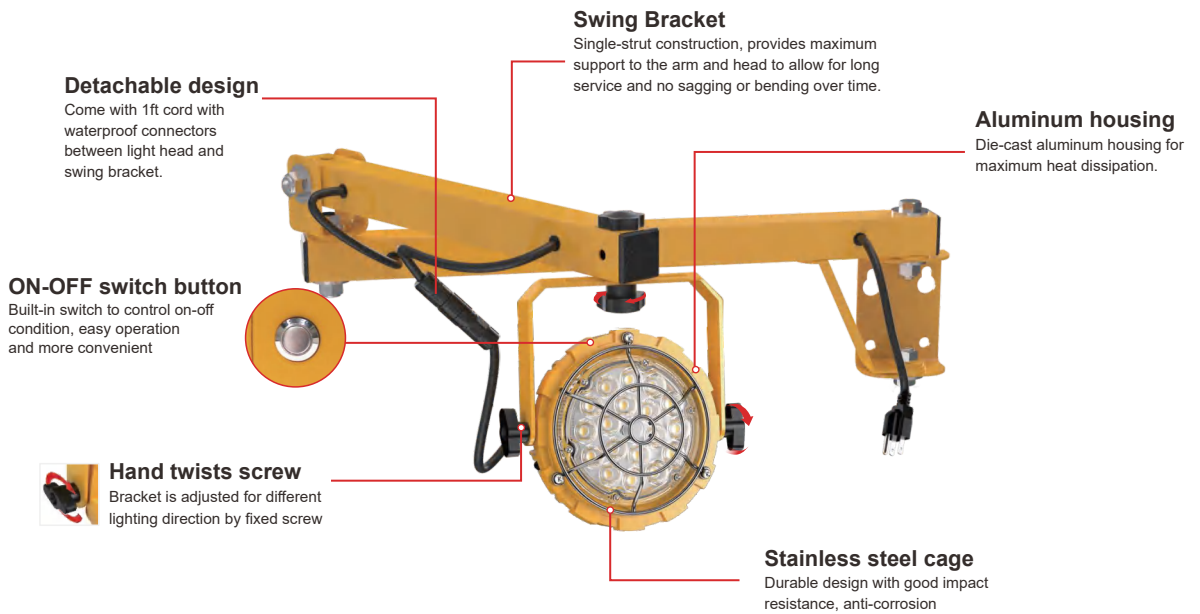

**Features**

1. Using EPISTAR LEDs, high lumens up to 130LPW.
2. High light transmittance PC lens.
3. High reliable constant current LED driver.
4. Available in multiple swing brackets optional.
5. UL/cUL/FCC/CE/RoHS approved.
6. >50,000 hours lifespan, offer 5 years warranty.



## Dimension

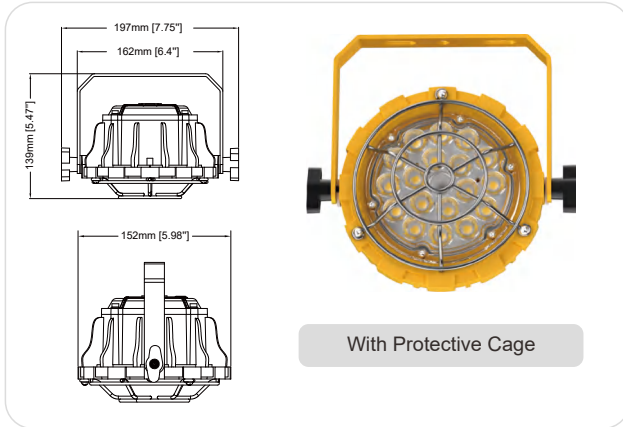

## Product Display



Cord length of bracket is 5ft(1500mm),  
US/EU/AU AC plug optional

## Application

Applications include shipping and receiving loading docks, machine stations such as a stamping press, inspection stations, general work lighting, indoor and outdoor spot lighting, and other similar applications.

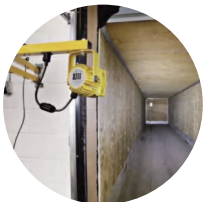

# RMS-L2001

## SPECIFICATIONS



Item NO.	Watt	Total Lumens	Beam Angle	LED Brand	CCT	Input Voltage	CRI	Power Factor	IP Rating
RMS-L200120	20W	2800lm	30°	EPISTAR	3000K 4000K 5000K 5700K 6500K	100-277V/120V with plug, 50-60Hz	≥80	≥0.9	IP65
RMS-L200130	30W	4200lm							
RMS-L200140	40W	5600lm							
RMS-L200150	50W	7000lm							

Remarks: All lumen specs are based on 5000K

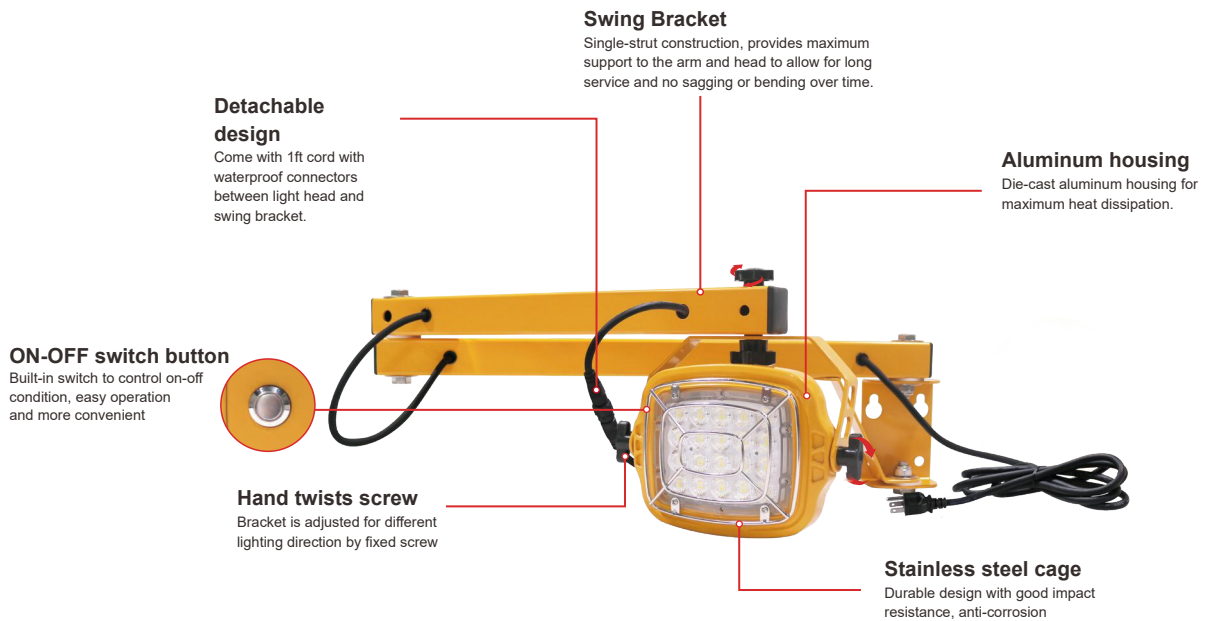

## Features

1. Using EPISTAR LEDs, high lumens up to 140LPW.
2. High light transmittance PC lens.
3. High reliable constant current LED driver.
4. Available in multiple swing brackets optional.
5. UL/cUL/FCC/CE/RoHS approved.
6. >50,000 hours lifespan, offer 5 years warranty.



## Dimension

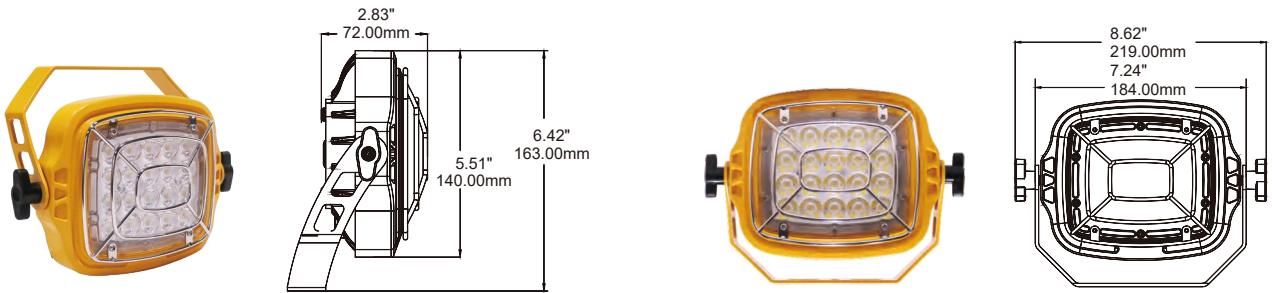

## Product Display



Single Arm



Double Arm



Arm with the receptacles

Cord length of bracket is 5ft(1500mm),  
120v US grounded plug optional

## Application

Applications include shipping and receiving loading docks, machine stations such as a stamping press, inspection stations, general work lighting, indoor and outdoor spot lighting, and other similar applications.



## RMS-DL SPECIFICATIONS



Item NO.	Watt	Total Lumens	Beam Angle	LED Brand	CCT	Input Voltage	CRI	Power Factor	IP Rating
RMS-DL-20W	20W	2200lm	20°/30°/110°	EPISTAR	3000K 4000K 5000K 5700K 6500K	100-277V/120V with plug, 50-60Hz	≥80	≥0.9	IP65
RMS-DL-30W	30W	3300lm							
RMS-DL-50W	50W	5500lm	30°/80°/110°						
RMS-DL-60W	60W	6600lm							

Remarks: All lumen specs are based on 5000K

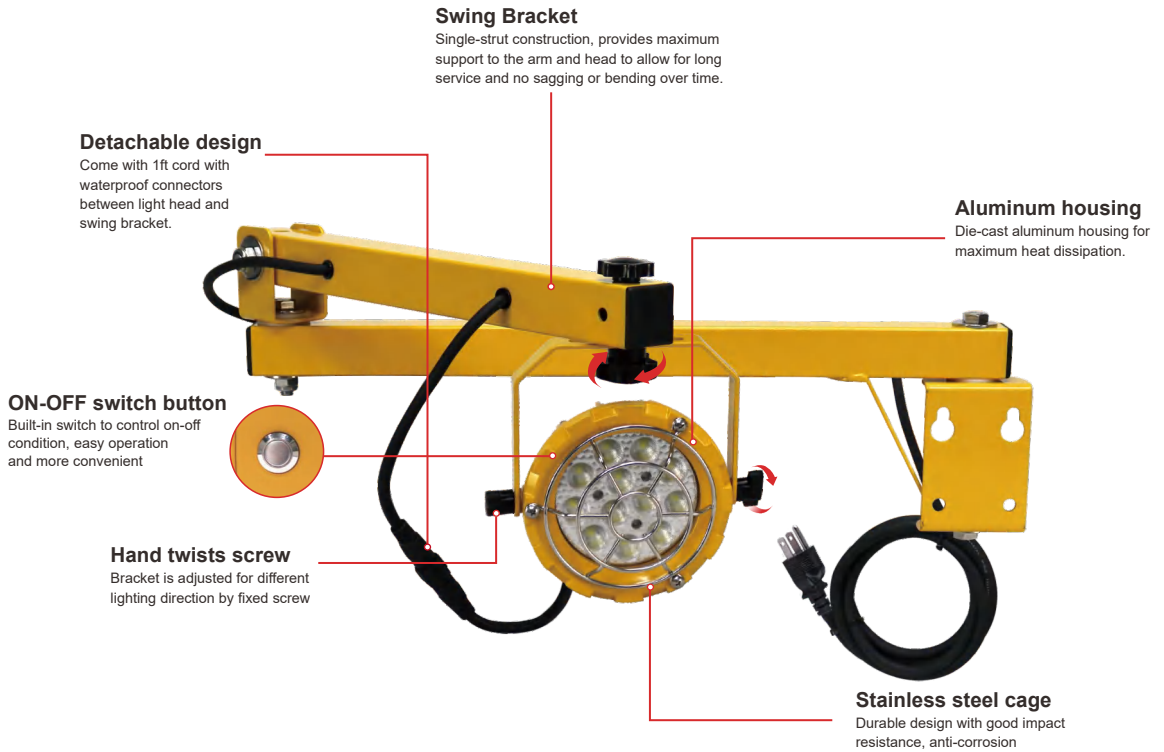

## Features

1. Using EPISTAR/CREE LEDs, high lumens up to 110LPW.
2. Tempered glass enhances safety and durability.
3. High reliable constant current LED driver.
4. Available in multiple swing brackets optional.
5. UL/cUL/FCC/CE/RoHS approved.
6. >50,000 hours lifespan, offer 5 years warranty.



## Dimension

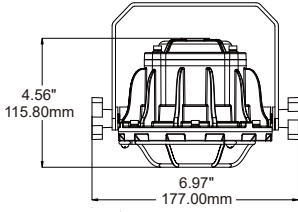

20W/30W

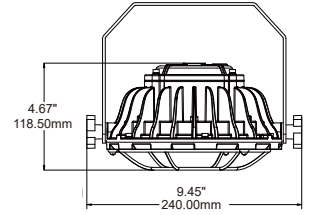
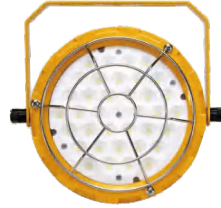

50W/60W

## Product Display



Single Arm



Double Arm



Arm with the receptacles

Cord length of bracket is 5ft(1500mm),  
120v US grounded plug optional

## Application

Applications include shipping and receiving loading docks, machine stations such as a stamping press, inspection stations, general work lighting, indoor and outdoor spot lighting, and other similar applications.



**RMS-L210220**  
**SPECIFICATIONS**



Item NO.	Watt	Total Lumens	Beam Angle	LED Brand	CCT	Input Voltage	Arm Length	Power Factor	IP Rating
RMS-L210220	20W	3000lm	20°	CREE/ EPISTAR	3000K 4000K 5000K 5700K 6500K	100-277V/120V with plug, 50-60Hz	700mm	≥0.9	IP65 (lamp head)

Remarks: All lumen specs are based on 5000K

**Unique Flexible Steel Arm**

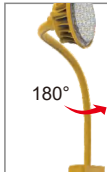

**Flexible gooseneck design**

- 27" gooseneck arm length.
- Easily bending and positioning, will not sag.
- Can be rotated 180 degrees for use in any direction.

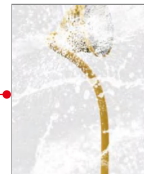

**Rubber insulation protection design**

- Rubber surface design for electrical insulation protection.
- IP65 high level of dustproof and waterproof.

**Anti-corrosion Mounting Box**



**Easy installation**

- Come with 4 key slots for easy mounting.
- 6ft power cord with optional US/EU/AU plug.



**Corrosion resistant design**

- Powder coated with safety yellow color.
- Built-in switch to control on-off condition conveniently.

**Features**

1. Using EPISTAR/CREE LEDs, high lumens up to 150LPW.
2. High light transmittance PC lens.
3. High reliable constant current LED driver.
4. 27" durable flexible gooseneck.
5. UL/cUL/FCC/CE/RoHS approved.
6. >50,000 hours lifespan, offer 5 years warranty.



# Dimension

Unit: inch/mm

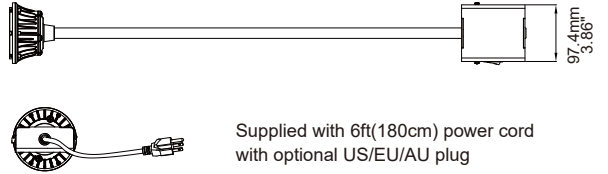
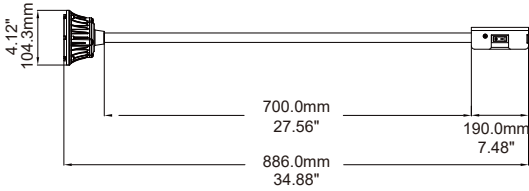

# Product Display



DC24V version

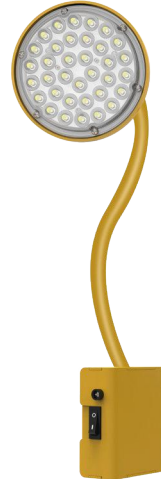

AC100-277V version

# Application

Romanso led gooseneck dock light is fast and easy installation on any vertical surface makes it ideal for both loading dock and factory floor lighting applications.

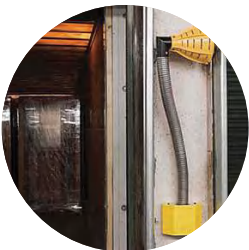

**RMS-L210220**



**Features**

1. Accepts incandescent bulbs up to 300 watts.
2. E26/E39 socket accepts PAR30/PAR38 bulbs (sold separately).
3. Wire lamp guard included.
4. Built-in on/off switch on the light head.
5. Adjustable arm knuckle joint allows vertical and horizontal positioning.
6. Available in multiple swing brackets optional.
7. UL/cUL/CE/RoHS approved.



**Product Display**



Single Arm



Double Arm with the 2 of receptacles



Double Arm

**Dimension**

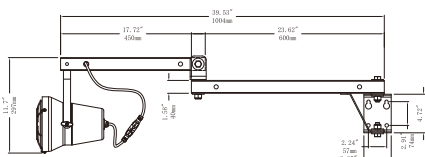

Single Arm

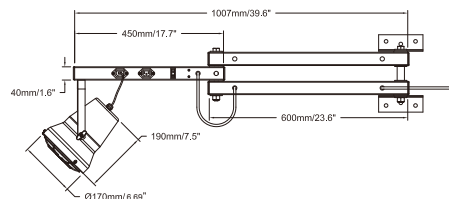

Double Arm with the 2 of receptacles

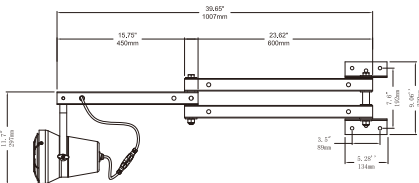

Double Arm

# LED TEMPORARY WORK LIGHT SERIES

ROMANSO LED Temporary Work Fixture is ideal for a wide range of construction job sites and maintenance activities, with features designed to fit any application. It offers a long lifespan, superior energy efficiency of up to 75%, quick installation, plug-and-play instant operation, and portable, durable temporary lighting.



**RMS-L2313**  
**SPECIFICATIONS**



Item NO.	Watt	Total Lumens	Dimension	CCT	Input Voltage	CRI	Power Factor	Operating Temperature	Beam Angle
RMS-L231360	60W	7200lm	Ø165*H268mm	3000K 4000K 5000K 5700K 6500K	AC120V with plug, 50-60Hz	≥80	>0.9	-40°C to 60°C	360°
RMS-L2313100	100W	12000lm	Ø165*H288mm						
RMS-L2313150	150W	18000lm	Ø165*H318mm						
RMS-L2313200	200W	24000lm	Ø165*H368mm						

Remarks: All lumen specs are based on 5000K



**Built-in socket**

Can be linked one by one, maximum of 10pcs 60W or 6pcs 100w or 4pcs 150w

**Portable hook**

Easy to carry and install  
Flexible with spring



**Wattage Adjustable**

Easily to adjust the brightness by switch button from 100%-50%-OFF

**Heavy-duty welded lamp cage**

Steel stainless material  
Strong & durable

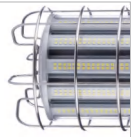

**Ventilation air-flow heat sink**

Better heat dissipation  
Extended working lifetime

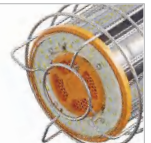

**120V USA plug with cord**

Cord length: 10ft  
Cord type: 18AWG



**Features**

1. Ultra-bright: 120lm/W.
2. Built-in on/off switch for easy operation.
3. Easily to adjust the brightness by switch button from 100%-50%-OFF.
4. Operating temperature: -40°C to 60°C.
5. Ventilation air-flow heat sink design for best heat dissipation.
6. Linkable function with 120V USA Plug and cord.
7. UL/cUL/CE/RoHS/FCC approved.
8. >50,000 hours lifespan, 5 years warranty.



## Multifunctional Design



Built-in socket, can be linked one by one.



Overlay design, more flexible for different application.

## Dimension

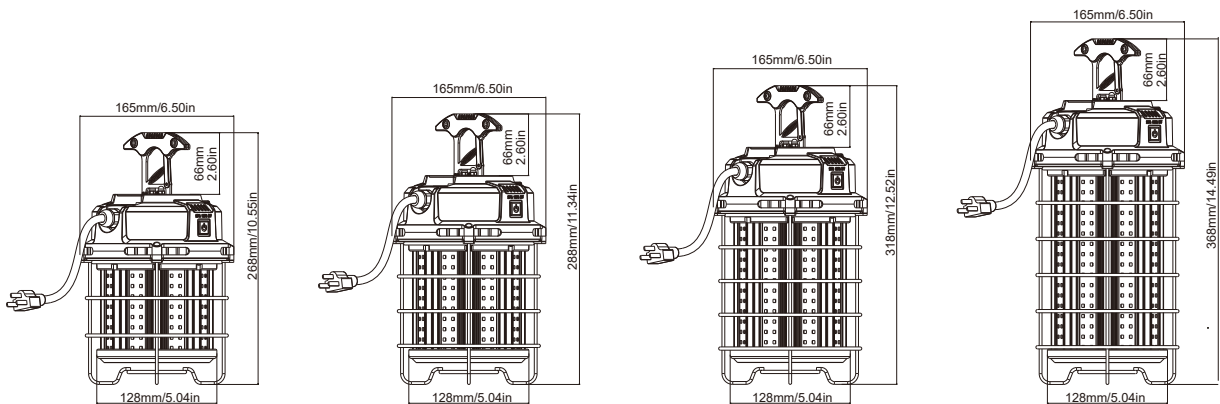

60W

100W

150W

200W

## Application

- \* New Building Construction or Renovation.
- \* Maintenance or storage spaces in commercial or institutional facilities.
- \* Short-term maintenance projects.
- \* Warehouses, factories, Exhibition halls and workshops.
- \* Highway toll stations and gas stations.



# RMS-K5-II

## SPECIFICATIONS



Item NO.	Watt	Total Lumens	Dimension	CCT	Input Voltage	CRI	Power Factor	Operating Temperature	Beam Aangle
RMS-K5-II-60W	60W	7200lm	Ø165*H273mm	3000K 4000K 5000K 5700K 6500K	AC120V with plug, 50-60Hz	≥80	>0.9	-40°C to 60°C	360°
RMS-K5-II-100W	100W	12000lm	Ø165*H288mm						
RMS-K5-II-150W	150W	18000lm	Ø165*H323mm						

Remarks: All lumen specs are based on 5000K

**Portable hook**  
Easy to carry and install  
Flexible with spring



**Built-in socket**  
Can be linked one by one, maximum of 10pcs 60W or 6pcs 100w or 4pcs 150w



**Heavy-duty welded lamp cage**  
Steel stainless material  
Strong & durable



**120V USA plug with cord**  
Cord length: 10ft  
Cord type: 18AWG



**Ventilation air-flow heat sink**  
Better heat dissipation  
Extended working lifetime



## Features

1. Ultra-bright: 120lm/W.
2. Come with 10-foot 18AWG cord and 120V plug.
3. Suitable for dry and damp location.
4. Ventilation air-flow heat sink design for better heat dissipation.
5. Operating temperature: -40°C to 60°C.
6. UL/cUL/ETL/cETL/CE/RoHS/FCC approved.
7. >50,000 hours lifespan, 5 years warranty



## Multiple Bracket Accessories Options



Classical bracket



Magnetic bracket



Tripod stand

## Dimension

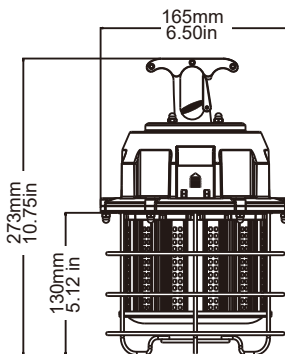

60W

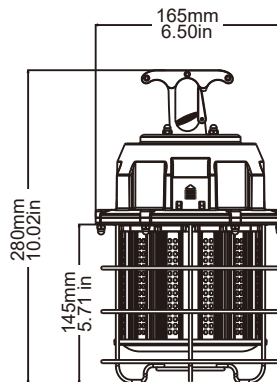

100W

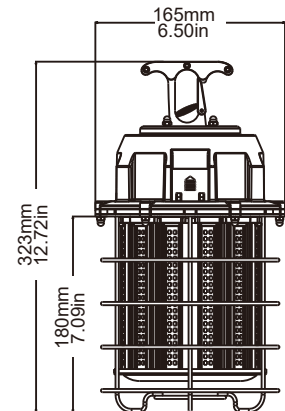

150W

## Application

- \* New Building Construction or Renovation.
- \* Maintenance or storage spaces in commercial or institutional facilities.
- \* Short-term maintenance projects.
- \* Warehouses, factories, Exhibition halls and workshops.
- \* Highway toll stations and gas stations.



**RMS-L2507**  
**SPECIFICATIONS**



Item NO.	Watt	Total Lumens	Dimension	CCT	Input Voltage	CRI	Power Factor	Operating Temperature	Beam Aangle
RMS-L250760	60W	7200lm	Ø135*H179mm	3000K 4000K 5000K 5700K 6500K	AC120V with plug, 50-60Hz	≥80	>0.9	-40°C to 60°C	360°
RMS-L2507100	100W	12000lm	Ø135*H227mm						
RMS-L2507150	150W	18000lm	Ø135*H287mm						

Remarks: All lumen specs are based on 5000K

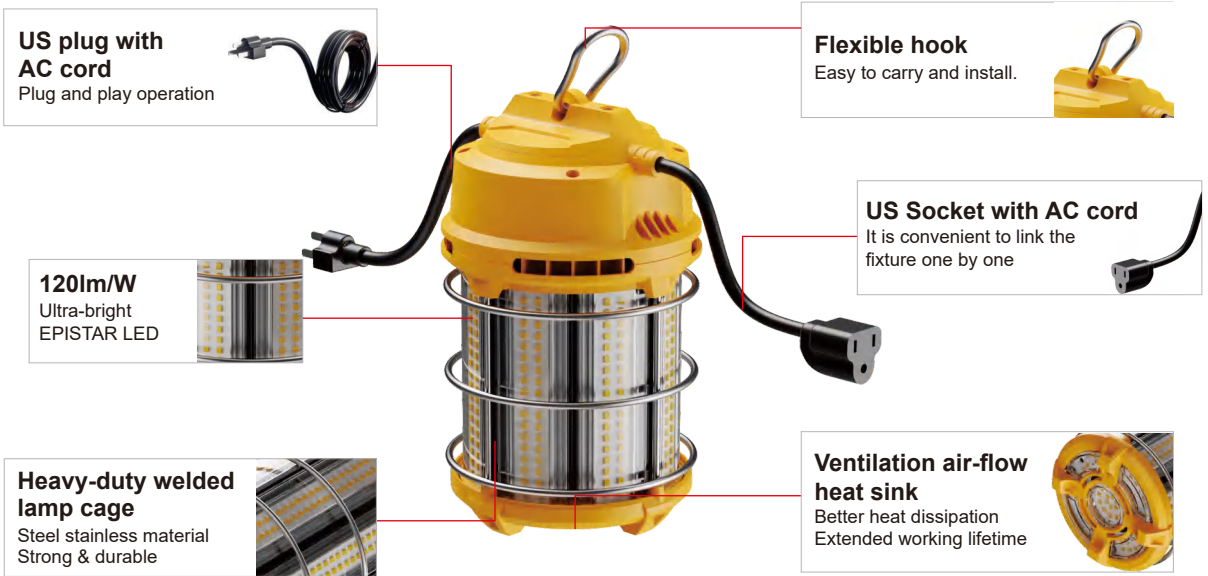

**Features**

1. Ultra-bright: 120lm/W.
2. Come with 10-foot 18AWG cord and 120V plug.
3. Suitable for dry and damp location.
4. Ventilation air-flow heat sink design for better heat dissipation.
5. Operating temperature: -40°C to 60°C.
6. UL/cUL/ETL/cETL/CE/RoHS/FCC approved.
7. >50,000 hours lifespan, 5 years warranty



## Product Display



60W



100W



150W

## Dimension

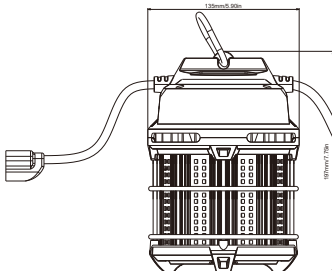

60W

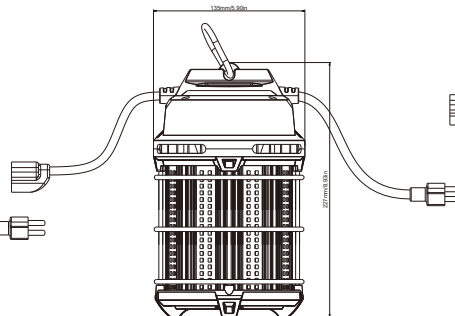

100W

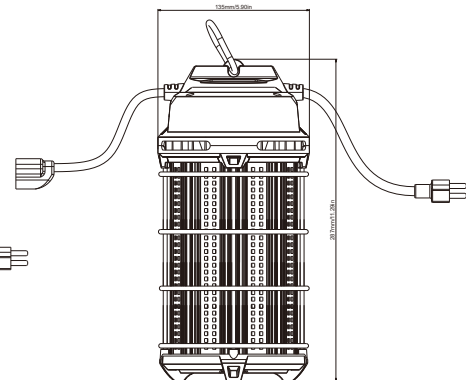

150W

## Application

- \* New Building Construction or Renovation.
- \* Maintenance or storage spaces in commercial or institutional facilities.
- \* Short-term maintenance projects.
- \* Warehouses, factories, Exhibition halls and workshops.
- \* Highway toll stations and gas stations.



# RMS-L2311

## SPECIFICATIONS



Item NO.	Watt	Total Lumens	Beam Angle	LED Brand	CCT	Input Voltage	CRI	IP Rat
RMS-L231180	80W (2x40W)	10000lm	120°	Epistar SMD2835	3000K 4000K 5000K 5700K 6500K	AC120V/ AC220V, 50-60Hz	≥80	IP65
RMS-L2311200	200W (2x100W)	23000lm						

Remarks: All lumen specs are based on 5000K

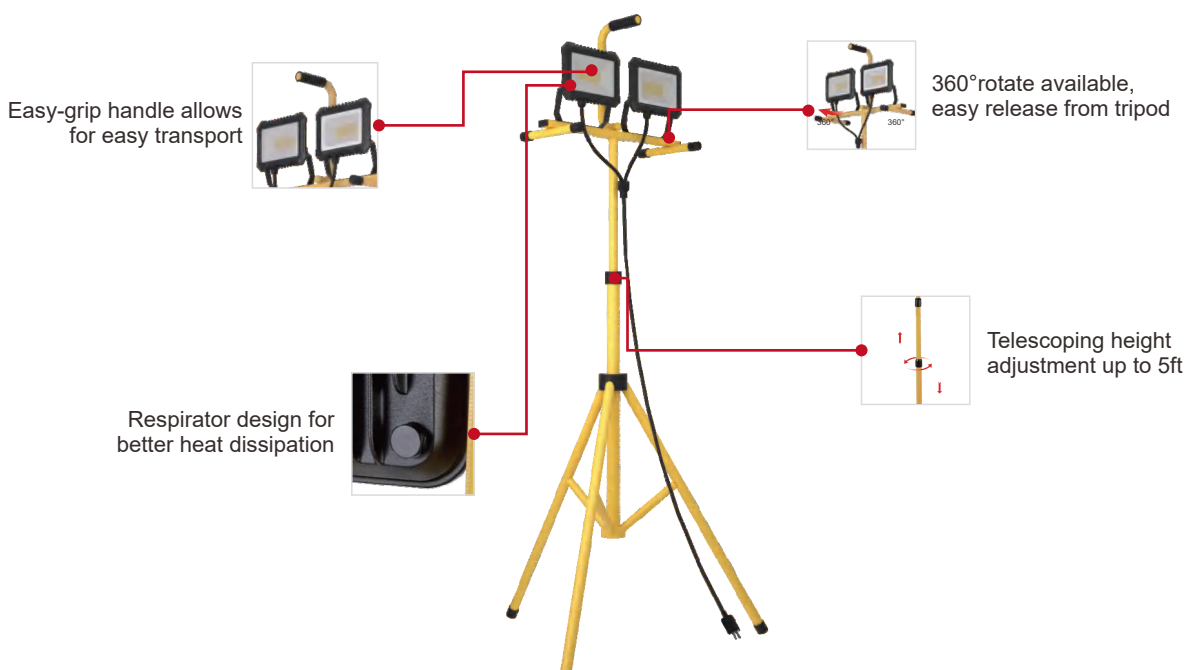

## Features

1. Dual lights head led outputs 10000lm/23000lm optional.
2. Built of a sturdy aluminum housing.
3. Built-in on/off switch for easy operation.
4. 5ft /10ft cord with a US/EU/AU AC plug optional.
5. Can be used with or without tripod.
6. Tripod stand total height is 5ft(150cm) available.
7. >50,000 hours lifespan, 5 years warranty.
8. UL/cUL/CE/RoHS/FCC approved.



## Product Display



## Dimension



## Application

Romanso led portable work light is ideal solution for construction, work sites, renovation projects, parking lots or other large areas where temporary lighting is needed.



# LED STRING WORK LIGHT SERIES

ROMANSO LED string work lights have 5 or 10 lights spaced 10 ft apart, producing 1000 to 2500 lumens per light. These work lights are ideal for job sites of any size. They are easy to set up and great for both outdoor and indoor workspaces. They come with a linkable design, giving you the flexibility to illuminate areas of different sizes, and they can be used in hazardous locations. They are primarily used in tunnels, maintenance areas, underground lighting, and construction sites.



# RMS-H5-4H

## SPECIFICATIONS



Item NO.	Watt	Lamp Quantity	Lumen	Length	CCT	Voltage	CRI	Beam Angle	Awg Size	IP Rating
RMS-H5-4H-8000	65W	5pcs	8000lm	50ft	3000K 4000K 5000K 5700K 6500K	AC120V	≥80	270°	18/16	IP65
RMS-H5-4H-16000	130W	10pcs	16000lm	100ft						

Remarks: All lumen specs are based on 5000K



50FT



100FT



Milky cover with 270° beam angle, soft light



With plastic cage, better protection on the light source



Flexible hook, easy installation



The AC plug with waterproof cover

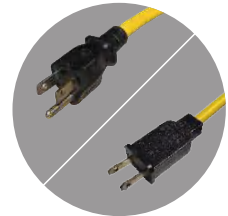

1-15P & 1-15R plug and 5-15P & 5-15R plug are available

## Features

1. 5 lights or 10 lights per bunch for option. Suitable to different demands of distance.
2. Light heads spaced 10 feet/3mts apart, same to traditional string work light.
3. Available in 18AWG/16AWG power wire.
4. Each lamp with metal hook, flexible for easy intallation.
5. Misty PC cover protect eyes better, anti-dazzle design.
6. Over 50000 hours lifetime and offer 5 years warranty.
7. UL/cUL/ETL/cETL/CE/RoHS certificates.

**RMS-H5-4H**  
**SPECIFICATIONS**



Item NO.	Watt	Lamp Quantity	Lumen	Length	CCT	Voltage	CRI	Beam Angle	Awg Size	IP Rating
RMS-H5-4H-10000	65W	5pcs	8000lm	50ft	3000K 4000K 5000K 5700K 6500K	AC120V	≥80	270°	18/16	IP65
RMS-H5-4H-20000	130W	10pcs	16000lm	100ft						

Remarks: All lumen specs are based on 5000K



50FT



100FT



Milky cover with 270° beam angle, soft light



With metal cage, better protection on the light source



Flexible hook, easy installation



The AC plug with waterproof cover



1-15P & 1-15R plug and 5-15P & 5-15R plug are available

**Features**

1. 5 lights or 10 lights per bunch for option. Suitable to different demands of distance.
2. Light heads spaced 10 feet/3mts apart, same to traditional string work light.
3. Available in 18AWG/16AWG power wire.
4. Each lamp with metal hook, flexible for easy intallation.
5. Misty PC cover protect eyes better, anti-dazzle design.
6. Over 50000 hours lifetime and offer 5 years warranty.
7. UL/cUL/ETL/cETL/CE/RoHS certificates.

# RMS-H5-4S

## SPECIFICATIONS



Item NO.	Watt	Lamp Quantity	Lumen	Length	CCT	Voltage	CRI	Beam Angle	Awg Size	IP Rating
RMS-H5-4S-6000	50W	5pcs	6000lm	50ft	3000K 4000K 5000K 5700K 6500K	AC120V AC240V	≥80	270°	18/16	IP65
RMS-H5-4S-12000	100W	10pcs	12000lm	100ft						

Remarks: All lumen specs are based on 5000K

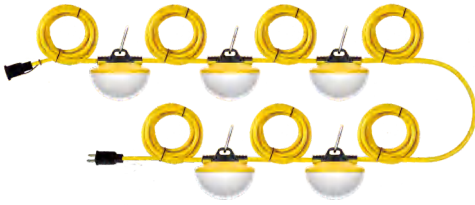

50FT



100FT



Milky cover with 270° beam angle, soft light



With plastic cage, better protection on the light source

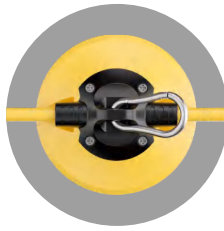

Flexible hook, easy installation



The AC plug with waterproof cover

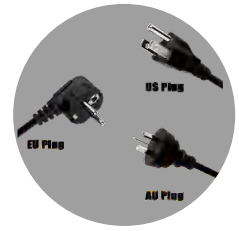

US/AU/EU plug optional

## Features

1. 5 lights or 10 lights per bunch for option. Suitable to different demands of distance.
2. Light heads spaced 10 feet/3mts apart, same to traditional string work light.
3. Available in 18AWG/16AWG power wire.
4. Each lamp with metal hook, flexible for easy intallation.
5. Misty PC cover protect eyes better, anti-dazzle design.
6. Over 50000 hours lifetime and offer 5 years warranty.
7. UL/cUL/ETL/cETL/CE/RoHS certificates.

**RMS-H5-4S**  
**SPECIFICATIONS**



Item NO.	Watt	Lamp Quantity	Lumen	Length	CCT	Voltage	CRI	Beam Angle	Awg Size	IP Rating
RMS-H5-4S-6000	50W	5pcs	6000lm	50ft	3000K 4000K 5000K 5700K 6500K	AC120V AC240V	≥80	270°	18/16	IP65
RMS-H5-4S-12000	100W	10pcs	12000lm	100ft						

Remarks: All lumen specs are based on 5000K



50FT



100FT



Milky cover with 270° beam angle, soft light

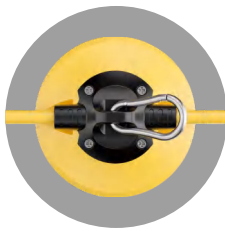

Flexible hook, easy installation



The AC plug with waterproof cover

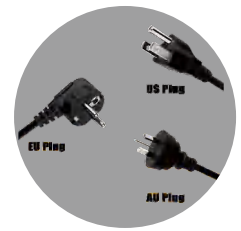

US/AU/EU plug optional

**Features**

1. 5 lights or 10 lights per bunch for option. Suitable to different demands of distance.
2. Light heads spaced 10 feet/3mts apart, same to traditional string work light.
3. Available in 18AWG/16AWG power wire.
4. Each lamp with metal hook, flexible for easy intallation.
5. Misty PC cover protect eyes better, anti-dazzle design.
6. Over 50000 hours lifetime and offer 5 years warranty.
7. UL/cUL/ETL/cETL/CE/RoHS certificates.

# Dimension

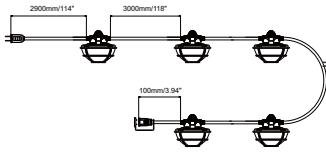

Option 1: It has 5 LED light heads and comes with a 50ft/ AC cord. Light heads spaced 10 feet/3mts apart

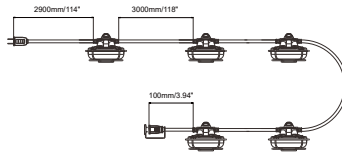

Option 1: It has 5 LED light heads and comes with a 50ft/ AC cord. Light heads spaced 10 feet/3mts apart

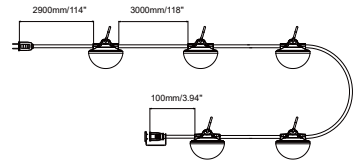

Option 1: It has 5 LED light heads and comes with a 50ft/ AC cord. Light heads spaced 10 feet/3mts apart

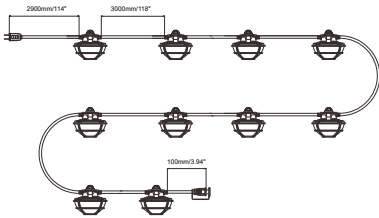

Option 2: It has 10 LED light heads and comes with a 100ft/ AC cord. Light heads spaced 10 feet/3mts apart

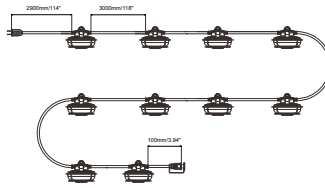

Option 2: It has 10 LED light heads and comes with a 100ft/ AC cord. Light heads spaced 10 feet/3mts apart

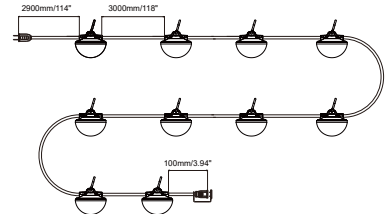

Option 2: It has 10 LED light heads and comes with a 100ft/ AC cord. Light heads spaced 10 feet/3mts apart

H5-4H ROUND VERSION

H5-4H FLAT VERSION

H5-4S VERSION

# Test Data Maximum Linkable Quantity

Working Condition: Input voltage is AC120V, each light head spaced 10ft apart, the maximum quantity for fixture's plug to link another fixture's socket, without extra power cord

AWG Size:	Model Number:	50W, same power	100W, same power	65W, same power	130W, same power
18AWG		8 pieces	4 pieces	6 pieces	3 pieces
16AWG		13 pieces	6 pieces	9 pieces	5 pieces

# Application

- \* New Building Construction or Renovation.
- \* Maintenance or storage spaces in commercial or institutional facilities.
- \* Short-term maintenance projects.
- \* Warehouses, factories, Exhibition halls and workshops.
- \* Highway toll stations and gas stations.





# ROMANSO<sup>®</sup>

**SHENZHEN ROMANSO ELECTRONIC CO., LTD.**

Add: 3F, No.1 Building, Guanghui industrial park, Tianbao road, Yingrenshi community,  
Shiyan town, Baoan district, Shenzhen  
Tel: +86-0755-29197500  
E-mail: romanso@romanso.com | Website: www.romanso.com

**ROMANSO ELECTRONIC CO., LTD.**

Add: Rm 20 Unit B3, 07/FL Tuen Mun, IND CTR NO 2 San Ping Circuit, Tuen Mun,  
Hong Kong  
Tel: +852 84001207

**TW LIGHTS CO., LTD.**

Add: Ou Ta Pung, Roka Kaoh, Kong Pisei, Kampong Speu, Cambodia  
Tel: +855 98770307



Ver. 2025/10