



ROMANSO

2025 Public LED Lighting Catalog
LIGHTING THE BUSINESSES OF TOMORROW TODAY!



ROMANSO[®]
SINCE 2007

Our Vision

Lighting the Businesses of Tomorrow Today!

Romanso was founded in 2007, and is a professional manufacturer with ISO9001:2015 approval and specializing in industrial and outdoor LED lighting products. And the production area is around 60,000 sq.ft and with over 110 staff. We're customer and market oriented, and keep upgrading the high efficiency LED lights with the latest LED technology. With the great warranty policy and after-sales services, we won a high reputation from our esteemed customers and satisfied them much. In 2023, Romanso set up a new branch factory in Cambodia. The total land area occupied by the facility land size is 130,000 sq.ft. The Cambodia branch is ISO-verified factory with 200 workers, all production procedures are according to Iso9001 quality standards, the defective rate is <math><0.3\%</math>.



Shenzhen Headquarters

Our Product

Romanso products are with industry-leading warranties and customer support. Main products are certificated by UL/cUL/ETL/cETL/TUV/SAA/FCC/CE/RoHS and most listed by DesignLights Consortium® (DLC). Romanso owns an experienced professional R&D engineering team who commitment to develop more new products to satisfy market demand and keep launching 2 to 3 new series every year. Newest testing equipment ensure products development and stability, including integrating sphere test, IES photoelectricity test, salt spray test, high and low temperature test, aging test, voltage surge test, withstand voltage test, insulation resistance tester, waterproof test and so on.



Shenzhen Factory

Our Capacity

Romanso throughout the whole processes of design, mould production, parts production, SMT production, assembly production and sales of finished led lighting products in house. Romanso owns mature production lines, equipped with die-casting machines, CNC machines, coating machines, painting machines, SMT machines, reflow soldering machines, drilling machine, bench grinder, ultrasonic machine, injection molding machine, glue potting machine, oven, laser machine, aging racks, automatic packing machines in the factory. Monthly production capacity can reach 120,000pcs LED fixtures.



Cambodian Factory

(equipped with die-casting workshop, SMT workshop, testing machines in house)



Front Desk



SMT Workshop



UL Authorized Laboratory



Showroom

Company Patents and Certifications



TABLE OF CONTENTS

Warehouse



P03-P04



P05-P06



P07-P09



P09-P10

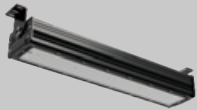

P11-P12



P13-P14



P15-P16

Parking



P17-P22



P23-P24



P25-P26



P27-P32

Exterior



P33-P34



P35-P38



P39-P40



P41-P42



P43-P44

Explosion proof



P45-P46



P47-P48

Retrofit



P49-P54

RMS-L2204 LED High Bay Series



PRODUCT FEATURES

- Light Efficiency: 150LPW as standard, 170LPW/190LPW optional.
- Power adjustable as standard, CCT adjustable optional.
- Emergency battery, motion sensor, ZHAGA sensor are optional.
- 0-10V dimming for low power consumption.
- Optics of 120°/ 90°/ 60° available on request.
- High-transmittance and anti-UV Polycarbonate lens.
- Die-casting aluminum with polyester powder coat finish.
- IP65/IK08 rating for outdoor usage.
- Hook hanging/U-bracket installation are available.
- DLC Premium/UL/cUL/ETL/CETL/FCC/CE/RoHS approval.
- 5 years warranty.



SPECIFICATION

Item NO.	Watt	Lumen	Dimension	CCT	Voltage	Beam Angle	CRI	PF
RMS-L220460	60W	9000LM	Ø230*147mm	3K-4K-5K-6K-6.5K	AC100-277V AC120-347V AC277-480V	60°/90°/120°	>80	>0.9
RMS-L220480	80W	12000LM	Ø230*147mm	3K-4K-5K-6K-6.5K	AC100-277V AC120-347V AC277-480V	60°/90°/120°	>80	>0.9
RMS-L2204100	100W	15000LM	Ø230*147mm	3K-4K-5K-6K-6.5K	AC100-277V AC120-347V AC277-480V	60°/90°/120°	>80	>0.9
RMS-L2204100	150W	22500LM	Ø275*161mm	3K-4K-5K-6K-6.5K	AC100-277V AC120-347V AC277-480V	60°/90°/120°	>80	>0.9
RMS-L2204200	200W	30000LM	Ø320*170mm	3K-4K-5K-6K-6.5K	AC100-277V AC120-347V AC277-480V	60°/90°/120°	>80	>0.9
RMS-L2204240	240W	36000LM	Ø320*170mm	3K-4K-5K-6K-6.5K	AC100-277V AC120-347V AC277-480V	60°/90°/120°	>80	>0.9
RMS-L2204300	300W	45000LM	Ø320*170mm	3K-4K-5K-6K-6.5K	AC100-277V AC120-347V AC277-480V	60°/90°/120°	>80	>0.9
RMS-L2204400	400W	60000LM	Ø390*202mm	3K-4K-5K-6K-6.5K	AC100-277V AC120-347V AC277-480V	60°/90°/120°	>80	>0.9
RMS-L2204500	500W	75000LM	Ø430*95mm	3K-4K-5K-6K-6.5K	AC100-277V AC120-347V AC277-480V	60°/90°/120°	>80	>0.9

Remarks: All lumen specs are based on 5000K

OFFERING
3 WATTAGE AND 3 CCT SELECTABLE
MEETS YOUR VARIOUS NEEDS!

WATTAGE SELECTABLE



100% 80% 60%

CCT SELECTABLE



3000K 4000K 5000K

OPTIONAL ACCESSORIES



RMS-HB LED High Bay Series



PRODUCT FEATURES

- Light Efficiency: 150LPW as standard, 170LPW optional.
- Power adjustable as standard, CCT adjustable optional.
- Optics of 120°/90°/60° available on request.
- 0-10V dimming for low power consumption.
- Emergency & PIR sensor function optional.
- High-transmittance and anti-UV Polycarbonate lens.
- Excellent thermal management design.
- Die-casting aluminum with polyester powder coat finish.
- IP65/IK08 rating for outdoor usage.
- Hook hanging/U-bracket installation are available.
- Energy savings, no UV and IR radiations, emits low heat.
- DLC/UL/cUL/ETL/CETL/FCC/CE/RoHS approval.
- 5 years warranty.



SPECIFICATION

Item NO.	Watt	Lumen	Dimension	CCT	Voltage	Beam Angle	CRI	PF
RMS-HB-100W	100W	15000LM	Ø280*164.8mm	3K-4K-5K-6K-6.5K	AC100~277V AC120~347V AC277~480V	60°/90°/120°	>80	>0.9
RMS-HB-150W	150W	22500LM	Ø280*164.8mm	3K-4K-5K-6K-6.5K	AC100~277V AC120~347V AC277~480V	60°/90°/120°	>80	>0.9
RMS-HB-200W	200W	30000LM	Ø340*169mm	3K-4K-5K-6K-6.5K	AC100~277V AC120~347V AC277~480V	60°/90°/120°	>80	>0.9
RMS-HB-240W	240W	36000LM	Ø340*169mm	3K-4K-5K-6K-6.5K	AC100~277V AC120~347V AC277~480V	60°/90°/120°	>80	>0.9
RMS-HB-300W	300W	45000LM	Ø340*169mm	3K-4K-5K-6K-6.5K	AC100~277V AC120~347V AC277~480V	60°/90°/120°	>80	>0.9

Remarks: All lumen specs are based on 5000K

OFFERING
3 WATTAGE AND 3 CCT SELECTABLE
MEETS YOUR VARIOUS NEEDS!

WATTAGE SELECTABLE			CCT SELECTABLE		
					
100%	80%	60%	3000K	4000K	5000K

OPTIONAL ACCESSORIES



RMS-HB LED High Bay Series

Temperature
up to
65°C



PRODUCT FEATURES

- Light Efficiency:130LPW.
- Compact High bay, quick and easy to install.
- Optics of 120°/90°/ 60° available on request.
- High reliable Meanwell/Inventronics LED driver.
- AC100-277V/AC120~347V/AC200~480V are available.
- Excellent thermal management design.
- Die-casting aluminum with polyester powder coat finish.
- IP65/IK08 rating for outdoor usage.
- Design for steelworks with high temperature (65°C.) and harsh environment, anti-electromagnetic interference.
- Hook hanging/U-bracket installation are available.
- Energy savings, no UV and IR radiations, emits low heat.
- UL/cUL/ETL/cETL/UKCA/FCC/CE/RoHS approval.
- 5 years warranty.



SPECIFICATION

Item NO.	Watt	Lumen	Dimension	CCT	Voltage	Beam Angle	CRI	PF
RMS-HB-300W	300W	39000LM	Ø400*196.5mm	3K-4K-5K-6K-6.5K	AC100~277V AC120~347V AC200~480V	60°/90°/120°	>80	>0.9
RMS-HB-400W	400W	52000LM	Ø400*196.5mm	3K-4K-5K-6K-6.5K	AC100~277V AC120~347V AC200~480V	60°/90°/120°	>80	>0.9
RMS-HB-500W	500W	65000LM	Ø460*241.5mm	3K-4K-5K-6K-6.5K	AC100~277V AC120~347V AC200~480V	60°/90°/120°	>80	>0.9

Remarks: All lumen specs are based on 5000K

APPLICATION

Ideal for high ceiling application, special design for steelworks, can be used in the demanding high temperature and harsh environment, anti-electromagnetic interference



OPTIONAL ACCESSORIES



RMS-H2402

LED High Bay Series



PRODUCT FEATURES

- Light Efficiency:110LPW.
- Compact High bay, quick and easy to install.
- Optics of 90° available on request.
- High-transmittance and anti-UV Polycarbonate lens.
- Excellent thermal management design.
- Die-casting aluminum with polyester powder coat finish.
- IP65/IK08 rating for outdoor usage.
- U-bracket installation as standard.
- Energy savings, no UV and IR radiations, emits low heat.
- UL/cUL/UKCA/FCC/CE/RoHS approval.
- 3 years warranty.



SPECIFICATION

Item NO.	Watt	Lumen	Dimension	CCT	Voltage	Beam Angle	CRI	PF
RMS-H2402100	100W	11000LM	Ø231.5*95.5mm	3K-4K-5K-6K-6.5K	AC120V AC220V	90°	>80	>0.9
RMS-H2402150	150W	16500LM	Ø285.5*101.5mm	3K-4K-5K-6K-6.5K	AC120V AC220V	90°	>80	>0.9
RMS-H2402200	200W	22000LM	Ø330*105.5mm	3K-4K-5K-6K-6.5K	AC120V AC220V	90°	>80	>0.9
RMS-H2402240	240W	26400LM	Ø349.8*105.5mm	3K-4K-5K-6K-6.5K	AC120V AC220V	90°	>80	>0.9
RMS-H2402300	300W	33000LM	Ø349.8*105.5mm	3K-4K-5K-6K-6.5K	AC120V AC220V	90°	>80	>0.9

Remarks: All lumen specs are based on 5000K

APPLICATION



OPTIONAL ACCESSORIES

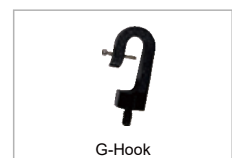

RMS-L2209 LED Linear High Bay Series



PRODUCT FEATURES

- Light Efficiency: 160LPW.
- High bright EPISTAR LEDs.
- Optics of 40x100/120° available on request.
- High-transmittance and anti-UV Polycarbonate lens.
- Excellent thermal management design.
- Die-casting aluminum with polyester powder coat finish.
- IP66/IK08 rating for outdoor usage.
- Suspend and ceiling installation is available.
- Energy savings, no UV and IR radiations, emits low heat.
- SAA/UKCA/FCC/CE/RoHS approval.
- 5 years warranty.

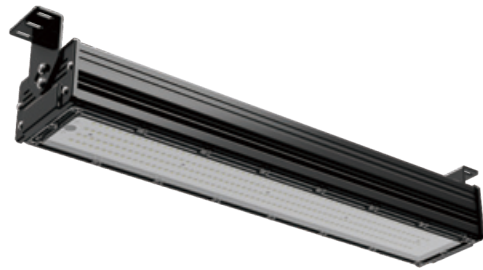

SPECIFICATION

Item NO.	Watt	Lumen	Dimension	CCT	Voltage	Beam Angle	CRI	PF
RMS-L220975	75W	12000LM	377*100*100mm	3K-4K-5K-6K-6.5K	AC100~277V AC120~347V AC277~480V	40x100° 120°	>80	>0.9
RMS-L2209100	100W	16000LM	615*100*100mm	3K-4K-5K-6K-6.5K	AC100~277V AC120~347V AC277~480V	40x100° 120°	>80	>0.9
RMS-L2209150	150W	24000LM	615*100*100mm	3K-4K-5K-6K-6.5K	AC100~277V AC120~347V AC277~480V	40x100° 120°	>80	>0.9
RMS-L2209200	200W	32000LM	893*100*100mm	3K-4K-5K-6K-6.5K	AC100~277V AC120~347V AC277~480V	40x100° 120°	>80	>0.9
RMS-L2209240	240W	38400LM	1171*100*100mm	3K-4K-5K-6K-6.5K	AC100~277V AC120~347V AC277~480V	40x100° 120°	>80	>0.9

Remarks: All lumen specs are based on 5000K

MOUNTING



OPTIONAL ACCESSORIES

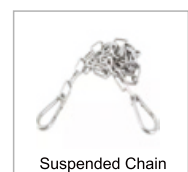
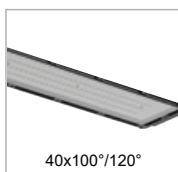

RMS-H2309

LED Linear High Bay Series



PRODUCT FEATURES

- Light Efficiency: 150LPW.
- Power and CCT adjustable are for optional.
- Prismatic diffuser reduces glare light toughly.
- Excellent thermal management design.
- Standard aircraft cable mounting, optional pendant or surface mounting.
- Suitable for damp location.
- Energy savings, no UV and IR radiations, emits low heat.
- 0-10V dimming standard, motion sensor, emergency battery optional.
- UL/cUL/UKCA/FCC/CE/RoHS approval.
- 5 years warranty.



SPECIFICATION

Item NO.	Watt	Lumen	Dimension	CCT	Voltage	Beam Angle	CRI	PF
RMS-H230990	90W	13500LM±10%	420*250*44.4mm	3K-4K-5K-6K-6.5K	120V-277V 347V-480V	90°	>80	>0.9
RMS-H2309130	130W	19500LM±10%	420*250*44.4mm	3K-4K-5K-6K-6.5K	120V-277V 347V-480V	90°	>80	>0.9
RMS-H2309175	175W	26250LM±10%	600*250*44.4mm	3K-4K-5K-6K-6.5K	120V-277V 347V-480V	90°	>80	>0.9
RMS-H2309210	210W	31500LM±10%	600*250*44.4mm	3K-4K-5K-6K-6.5K	120V-277V 347V-480V	90°	>80	>0.9
RMS-H2309270	270W	40500LM±10%	900*250*44.4mm	3K-4K-5K-6K-6.5K	120V-277V 347V-480V	90°	>80	>0.9
RMS-H2309300	300W	45000LM±10%	900*250*44.4mm	3K-4K-5K-6K-6.5K	120V-277V 347V-480V	90°	>80	>0.9
RMS-H2309400	400W	60000LM±10%	1200*250*44.4mm	3K-4K-5K-6K-6.5K	120V-277V 347V-480V	90°	>80	>0.9

Remarks: All lumen specs are based on 5000K

OFFERING
3 WATTAGE AND 3 CCT SELECTABLE
MEETS YOUR VARIOUS NEEDS!

WATTAGE SELECTABLE



100% 80% 60%

CCT SELECTABLE



3000K 4000K 5000K

OPTIONAL ACCESSORIES



Wire Guard



Plug-and-Play PIR Sensor



Microwave Sensor



Emergency Battery



Chain Mounting



Pendant Hanger

RMS-H2515 LED Vapor Tight Fixture Series



PRODUCT FEATURES

- Light Efficiency: 150LPW.
- Power and CCT adjustable as standard.
- Closed housing, sealed against moisture and environmental contaminants.
- Stainless steel clamp design, convenient assembly and separation of lamp body.
- 4 foot and 8 foot lengths available.
- IP65 rating - protection from water and debris.
- Energy savings, no UV and IR radiations, emits low heat.
- 0-10V dimming standard, motion sensor, emergency battery optional.
- ETL/cETL/UKCA/FCC/CE/RoHS approval.
- 5 years warranty.



SPECIFICATION

Item NO.	Watt	Lumen	Dimension	CCT	Voltage	Beam Angle	CRI	PF
RMS-H251560	60W	9000LM	1200*79*74mm	3K-4K-5K-6K-6.5K	AC100~277V AC120~347V AC200~480V	120°	>80	>0.9
RMS-H2515100	100W	15000LM	2930*98*85mm	3K-4K-5K-6K-6.5K	AC100~277V AC120~347V AC200~480V	120°	>80	>0.9

Remarks: All lumen specs are based on 5000K

OFFERING
4 WATTAGE AND 5 CCT SELECTABLE
MEETS YOUR VARIOUS NEEDS!

WATTAGE SELECTABLE



100% 80% 60% 40%

CCT SELECTABLE



3000K 3500K 4000K 5000K 6500K

OPTIONAL ACCESSORIES



RMS-L2401 LED Post Top Series



PRODUCT FEATURES

- High luminous efficiency up to 150LPW.
- Optics of 60°/90°/120° available on request.
- Power and CCT adjustable are for optional.
- Excellent thermal management design.
- Die-casting aluminum with polyester powder coat finish.
- IP65/IK08 rating for outdoor usage.
- Easy installation and low maintenance.
- Energy savings, no UV and IR radiations, emits low heat.
- 0-10V, photocell, motion sensor and timer control are optional.
- UL/cUL/UKCA/FCC/CE/RoHS approval.
- 5 years warranty.



SPECIFICATION

Item NO.	Watt	Lumen	Dimension	CCT	Voltage	Beam Angle	CRI	PF
RMS-L240160	60W	9000LM	Ø400*472mm	3K-4K-5K-6K-6.5K	AC100~277V AC120~347V AC277~480V	60°/90°/120°	>80	>0.9
RMS-L2401100	100W	15000LM	Ø400*472mm	3K-4K-5K-6K-6.5K	AC100~277V AC120~347V AC277~480V	60°/90°/120°	>80	>0.9
RMS-L2401150	150W	22500LM	Ø400*472mm	3K-4K-5K-6K-6.5K	AC100~277V AC120~347V AC277~480V	60°/90°/120°	>80	>0.9

Remarks: All lumen specs are based on 5000K

OFFERING
3 WATTAGE AND 3 CCT SELECTABLE
MEETS YOUR VARIOUS NEEDS!

WATTAGE SELECTABLE



100% 80% 60%

CCT SELECTABLE



3000K 4000K 5000K

OPTIONAL ACCESSORIES

					
Slip Fitter	Suspended Bracket	Photocell	Motion sensor	Shorting cap	10KV Surge Protector

RMS-H2506 LED Post Top Series



PRODUCT FEATURES

- High luminous efficiency up to 150LPW.
- Optics of T3, T4, and T5 light distributions available on request.
- On-site adjustments for wattage, CCT and beam angle optional.
- Excellent thermal management design.
- Die-casting aluminum with polyester powder coat finish.
- IP65/IK08 rating for outdoor usage.
- Easy installation and low maintenance.
- Energy savings, no UV and IR radiations, emits low heat.
- 0-10V, photocell, motion sensor and timer control are optional.
- UL/cUL/UKCA/FCC/CE/RoHS approval.
- 5 years warranty.



SPECIFICATION

Item NO.	Watt	Lumen	Dimension	CCT	Voltage	Beam Angle	CRI	PF
RMS-H250645	45W	6750LM	Ø456.5*632mm	3K-4K-5K-6K-6.5K	AC120~277V AC120~347V AC277~480V	T3/T4/T5	>80	>0.9
RMS-H250690	90W	13500LM	Ø456.5*632mm	3K-4K-5K-6K-6.5K	AC120~277V AC120~347V AC277~480V	T3/T4/T5	>80	>0.9
RMS-H2506130	130W	19500LM	Ø456.5*632mm	3K-4K-5K-6K-6.5K	AC120~277V AC120~347V AC277~480V	T3/T4/T5	>80	>0.9

Remarks: All lumen specs are based on 5000K

OFFERING

4 WATTAGE AND 3 CCT SELECTABLE

MEETS YOUR VARIOUS NEEDS!

WATTAGE SELECTABLE

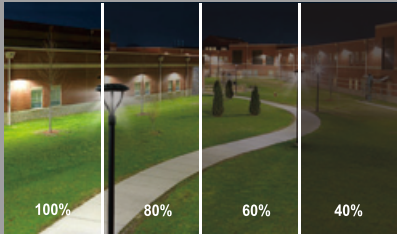

100% 80% 60% 40%

CCT SELECTABLE



3000K 4000K 5000K

OPTIONAL ACCESSORIES

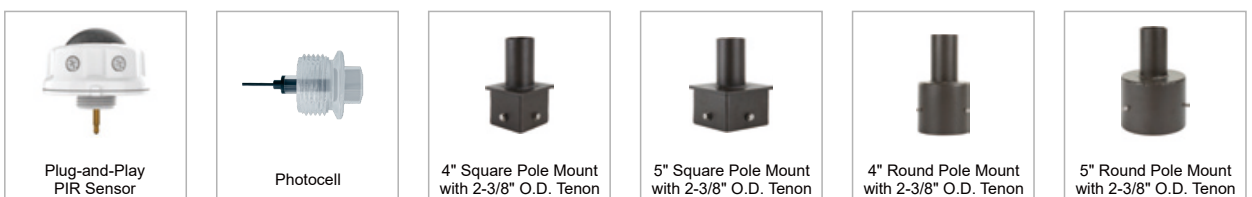

RMS-PT LED Post Top Series



PRODUCT FEATURES

- High luminous efficiency up to 130LPW.
- Optics of 108° and 118° available on request.
- Power and CCT adjustable are for optional.
- Excellent thermal management design.
- Die-casting aluminum with polyester powder coat finish.
- IP65/IK08 rating for outdoor usage.
- Easy installation and low maintenance.
- Energy savings, no UV and IR radiations, emits low heat.
- 0-10V, photocell, motion sensor and timer control are optional.
- DLC/UL/cUL /UKCA/ETL/cETL/FCC/CE/RoHS approval.
- 5 years warranty.



SPECIFICATION

Item NO.	Watt	Lumen	Dimension	CCT	Voltage	Beam Angle	CRI	PF
RMS-PT-60W	60W	7800LM	Ø360*520mm	3K-4K-5K-6K-6.5K	AC100~277V AC120~347V AC277~480V	108°/118°	>80	>0.9
RMS-PT-100W	100W	13000LM	Ø360*520mm	3K-4K-5K-6K-6.5K	AC100~277V AC120~347V AC277~480V	108°/118°	>80	>0.9
RMS-PT-150W	150W	19500LM	Ø360*520mm	3K-4K-5K-6K-6.5K	AC100~277V AC120~347V AC277~480V	108°/118°	>80	>0.9

Remarks: All lumen specs are based on 5000K

OFFERING
3 WATTAGE AND 3 CCT SELECTABLE
MEETS YOUR VARIOUS NEEDS!

WATTAGE SELECTABLE



100% 80% 60%

CCT SELECTABLE



3000K 4000K 5000K

OPTIONAL ACCESSORIES



RMS-L2117

LED Parking Lot Light Series



PRODUCT FEATURES

- High luminous efficiency 140LPW standard.
- Optics of Type III available on request.
- High-transmittance and anti-UV Polycarbonate lens.
- Excellent thermal management design.
- Die-casting aluminum with polyester powder coat finish.
- IP66/IK08 rating for outdoor usage.
- Mounting bracket for round and square pole for option.
- Energy savings, no UV and IR radiations, emits low heat.
- 0-10V, photocell, motion sensor and timer control are optional.
- UL/cUL/ETL/cETL/UKCA/FCC/CE/RoHS approval.
- 5 years warranty.



SPECIFICATION

Item NO.	Watt	Lumen	Dimension	CCT	Voltage	Beam Angle	CRI	PF
RMS-L2117100	100W	14000LM	499*310*75.5mm	3K-4K-5K-6K-6.5K	AC100-277V AC120-347V AC277-480V	Type III	>80	>0.9
RMS-L2117150	150W	21000LM	499*310*75.5mm	3K-4K-5K-6K-6.5K	AC100-277V AC120-347V AC277-480V	Type III	>80	>0.9
RMS-L2117200	200W	28000LM	499*310*75.5mm	3K-4K-5K-6K-6.5K	AC100-277V AC120-347V AC277-480V	Type III	>80	>0.9
RMS-L2117240	240W	33600LM	666*310*83mm	3K-4K-5K-6K-6.5K	AC100-277V AC120-347V AC277-480V	Type III	>80	>0.9
RMS-L2117300	300W	42000LM	666*310*83mm	3K-4K-5K-6K-6.5K	Ac120-277V AC120-347V AC277-480V	Type III	>80	>0.9
RMS-L2117400	400W	56000LM	666*310*83mm	3K-4K-5K-6K-6.5K	AC100-277V AC120-347V AC277-480V	Type III	>80	>0.9

Remarks: All lumen specs are based on 5000K

OFFERING
3 WATTAGE AND 3 CCT SELECTABLE
MEETS YOUR VARIOUS NEEDS!

WATTAGE SELECTABLE



100% 80% 60%

CCT SELECTABLE



3000K 4000K 5000K

OPTIONAL ACCESSORIES



RMS-H2318 LED Canopy Light Series



PRODUCT FEATURES

- Light Efficiency: 140-150LPW.
- Power and CCT adjustable are for optional.
- High-transmittance and anti-UV Polycarbonate lens.
- Excellent thermal management design.
- Die-casting aluminum with polyester powder coat finish.
- IP65/IK08 rating for outdoor usage.
- Energy savings, no UV and IR radiations, emits low heat.
- 0-10V dimming optional.
- UL/cUL/UKCA/FCC/CE/RoHS approval.
- 5 years warranty.







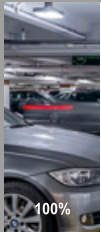

SPECIFICATION

Item NO.	Watt	Lumen	Dimension	CCT	Voltage	Beam Angle	CRI	PF
RMS-H231827	27W	3782~4050LM	241.8*241.8*81mm	3K-4K-5K-6K-6.5K	AC100~277V AC120~347V AC277~480V	150°	>80	>0.9
RMS-H231840	40W	5600~6000LM	241.8*241.8*81mm	3K-4K-5K-6K-6.5K	AC100~277V AC120~347V AC277~480V	150°	>80	>0.9
RMS-H231860	60W	8400~9000LM	241.8*241.8*81mm	3K-4K-5K-6K-6.5K	AC100~277V AC120~347V AC277~480V	150°	>80	>0.9
RMS-H2318120	120W	16800~18000LM	295.2*295.5*96.5mm	3K-4K-5K-6K-6.5K	AC100~277V AC120~347V AC277~480V	150°	>80	>0.9

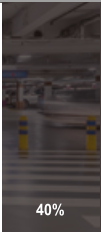
Remarks: All lumen specs are based on 5000K

OFFERING
4 WATTAGE AND 3 CCT SELECTABLE
MEETS YOUR VARIOUS NEEDS!

WATTAGE SELECTABLE				CCT SELECTABLE		
						
100%	80%	60%	40%	3000K	4000K	5000K

OPTIONAL ACCESSORIES

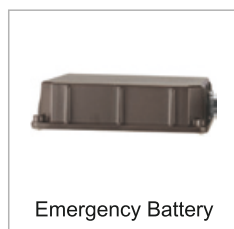
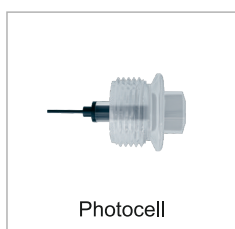

RMS-H2503 LED Canopy Light Series



PRODUCT FEATURES

- High luminous efficiency up to 137LPW.
- Power and CCT adjustable are for optional.
- High-transmittance and anti-UV Polycarbonate lens.
- Excellent thermal management design.
- Die-casting aluminum with polyester powder coat finish.
- IP65/IK08 rating for outdoor usage.
- Energy savings, no UV and IR radiations, emits low heat.
- 0-10V dimming standard, motion sensor optional.
- UL/cUL/UKCA/FCC/CE/RoHS approval.
- 5 years warranty.



SPECIFICATION

Item NO.	Watt	Lumen	Dimension	CCT	Voltage	Beam Angle	CRI	PF
RMS-H250330	30W	4000LM	Ø304.7*84.3mm	3K-4K-5K-6K-6.5K	AC120~277V AC120~347V AC277~480V	150°	>80	>0.9
RMS-H250345	45W	5700LM	Ø304.7*84.3mm	3K-4K-5K-6K-6.5K	AC120~277V AC120~347V AC277~480V	150°	>80	>0.9
RMS-H250350	50W	5700LM	Ø304.7*84.3mm	3K-4K-5K-6K-6.5K	AC120~277V AC120~347V AC277~480V	150°	>80	>0.9
RMS-H250360	60W	7600LM	Ø304.7*84.3mm	3K-4K-5K-6K-6.5K	AC120~277V AC120~347V AC277~480V	150°	>80	>0.9
RMS-H250365	65W	7600LM	Ø304.7*84.3mm	3K-4K-5K-6K-6.5K	AC120~277V AC120~347V AC277~480V	150°	>80	>0.9
RMS-H250390	90W	12300LM	Ø331*109mm	3K-4K-5K-6K-6.5K	AC120~277V AC120~347V AC277~480V	150°	>80	>0.9

Remarks: All lumen specs are based on 5000K

OFFERING
4 WATTAGE AND 2 CCT SELECTABLE
MEETS YOUR VARIOUS NEEDS!

WATTAGE SELECTABLE



100% 80% 60% 40%

CCT SELECTABLE



4000K 5000K

OPTIONAL ACCESSORIES

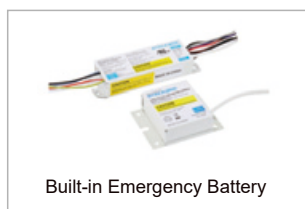

RMS-H2504 LED Canopy Light Series



PRODUCT FEATURES

- Light Efficiency: 140-150lm/W.
- Power and CCT adjustable are for optional.
- High-transmittance and anti-UV Polycarbonate lens.
- Excellent thermal management design.
- Die-casting aluminum with polyester powder coat finish.
- IP65/IK08 rating for outdoor usage.
- Energy savings, no UV and IR radiations, emits low heat.
- 0-10V dimming standard, motion sensor, emergency battery optional.
- UL/cUL/UKCA/FCC/CE/RoHS approval.
- 5 years warranty.



SPECIFICATION

Item NO.	Watt	Lumen	Dimension	CCT	Voltage	Beam Angle	CRI	PF
RMS-H250445	45W	6750LM	233*233*84mm	3K-4K-5K-6K-6.5K	AC120~277V AC120~347V AC277~480V	150°	>80	>0.9
RMS-H250460	60W	9000LM	233*233*84mm	3K-4K-5K-6K-6.5K	AC120~277V AC120~347V AC277~480V	150°	>80	>0.9
RMS-H250470	70W	10500LM	233*233*84mm	3K-4K-5K-6K-6.5K	AC120~277V AC120~347V AC277~480V	150°	>80	>0.9

Remarks: All lumen specs are based on 5000K

OFFERING
4 WATTAGE AND 3 CCT SELECTABLE
MEETS YOUR VARIOUS NEEDS!

WATTAGE SELECTABLE

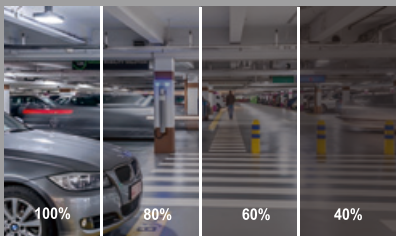

100% 80% 60% 40%

CCT SELECTABLE



3000K 4000K 5000K

OPTIONAL ACCESSORIES

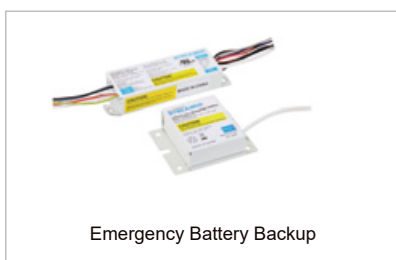

RMS-H2505

LED Gas Station Light Series



PRODUCT FEATURES

- Light Efficiency: 140-150lm/W.
- Power and CCT adjustable are for optional.
- Tempered glass lens is designed for excellent light output and uniformity.
- Excellent thermal management design.
- Die-casting aluminum with polyester powder coat finish.
- IP65/IK08 rating for outdoor usage.
- Energy savings, no UV and IR radiations, emits low heat.
- 0-10V dimming standard, motion sensor optional.
- UL/cUL/UKCA/FCC/CE/RoHS approval.
- 5 years warranty.



SPECIFICATION

Item NO.	Watt	Lumen	Dimension	CCT	Voltage	Beam Angle	CRI	PF
RMS-H2505100	100W	15000LM	400*400*223mm	3K-4K-5K-6K-6.5K	AC120~277V AC120~347V AC277~480V	150°	>80	>0.9
RMS-H2505150	150W	22000LM	400*400*223mm	3K-4K-5K-6K-6.5K	AC120~277V AC120~347V AC277~480V	150°	>80	>0.9

Remarks: All lumen specs are based on 5000K

OFFERING
4 WATTAGE AND 3 CCT SELECTABLE
MEETS YOUR VARIOUS NEEDS!

WATTAGE SELECTABLE



100% 80% 60% 40%

CCT SELECTABLE



3000K 4000K 5000K

OPTIONAL ACCESSORIES

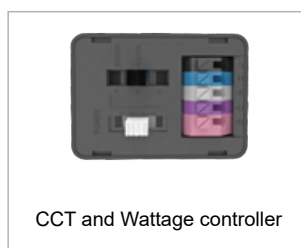
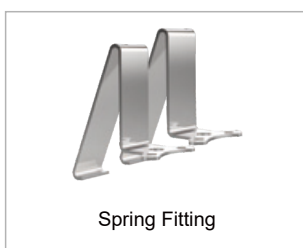

RMS-L2301 LED Wall Pack Series

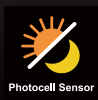

PRODUCT FEATURES

- Light Efficiency: 125LPW.
- Power and CCT adjustable are for optional.
- High-impact polycarbonate diffuser.
- Excellent thermal management design.
- Extruded aluminum alloy body with polyester powder coat finish.
- IP65/IK08 rating for outdoor usage.
- Energy savings, no UV and IR radiations, emits low heat.
- Standard with 0-10V dimming allowing for 0% to 100% dimming.
- DLC/UL/cUL/UKCA/FCC/CE/RoHS approval.
- 5 years warranty.



SPECIFICATION

Item NO.	Watt	Lumen	Dimension	CCT	Voltage	Beam Angle	CRI	PF
RMS-L230160	60W	7500LM	364*233*169mm	3K-4K-5K-6K-6.5K	AC100-277V AC120-347V AC277-480V	120°	>80	>0.9
RMS-L230180	80W	12000LM	364*233*169mm	3K-4K-5K-6K-6.5K	AC100-277V AC120-347V AC277-480V	120°	>80	>0.9
RMS-L2301100	100W	12500LM	364*233*169mm	3K-4K-5K-6K-6.5K	AC100-277V AC120-347V AC277-480V	120°	>80	>0.9
RMS-L2301120	120W	15000LM	364*233*169mm	3K-4K-5K-6K-6.5K	AC100-277V AC120-347V AC277-480V	120°	>80	>0.9

Remarks: All lumen specs are based on 5000K

OFFERING
3 WATTAGE AND 3 CCT SELECTABLE
MEETS YOUR VARIOUS NEEDS!

WATTAGE SELECTABLE



100% 80% 60%

CCT SELECTABLE



3000K 4000K 5000K

OPTIONAL ACCESSORIES

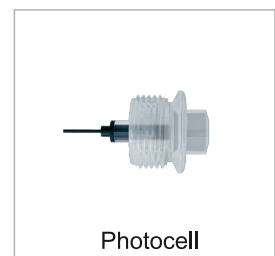

RMS-L2214 LED Full-Cutoff Wall Pack Series

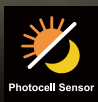
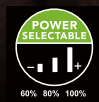
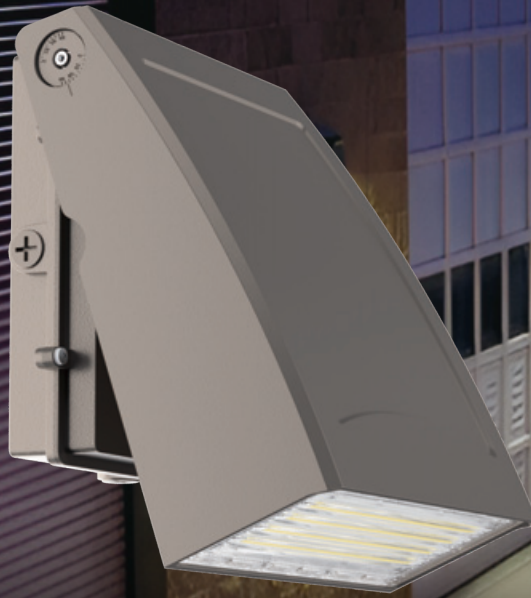

PRODUCT FEATURES

- Light Efficiency: 140LPW.
- Power and CCT adjustable are for optional.
- High-transmittance and anti-UV Polycarbonate lens.
- 0° to 90° field adjustable angle dial for flexible installation.
- Excellent thermal management design.
- Die-casting aluminum with polyester powder coat finish.
- IP66/IK08 rating for outdoor usage.
- Energy savings, no UV and IR radiations, emits low heat.
- 0-10V dimming, an integrated photocell optional.
- UL/cUL/UKCA/FCC/CE/RoHS approval.
- 5 years warranty.



SPECIFICATION

Item NO.	Watt	Lumen	Dimension	CCT	Voltage	Beam Angle	CRI	PF
RMS-L221460	60W	5600LM	165*205*100mm	3K-4K-5K-6K-6.5K	AC100-277V AC120-347V AC277-480V	90°x65°	>80	>0.9
RMS-L221480	80W	8400LM	165*205*100mm	3K-4K-5K-6K-6.5K	AC100-277V AC120-347V AC277-480V	90°x65°	>80	>0.9
RMS-L2214100	100W	14000LM	216*280*112mm	3K-4K-5K-6K-6.5K	AC100-277V AC120-347V AC277-480V	90°x65°	>80	>0.9
RMS-L2214120	120W	16800LM	267*330*126mm	3K-4K-5K-6K-6.5K	AC100-277V AC120-347V AC277-480V	90°x65°	>80	>0.9

Remarks: All lumen specs are based on 5000K

OFFERING
3 WATTAGE AND 3 CCT SELECTABLE
MEETS YOUR VARIOUS NEEDS!

WATTAGE SELECTABLE



100% 80% 60%

CCT SELECTABLE



3000K 4000K 5000K

OPTIONAL ACCESSORIES

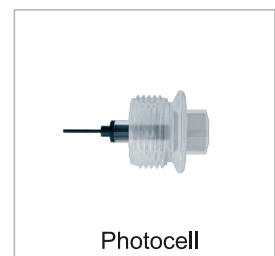

RMS-H2516

LED Full-Cutoff Wall Pack Series



PRODUCT FEATURES

- Light Efficiency: 150-160LPW.
- Power and CCT adjustable are for optional.
- High-impact polycarbonate diffuser.
- Excellent thermal management design.
- Die-casting aluminum with polyester powder coat finish.
- IP65/IK08 rating for outdoor usage.
- Energy savings, no UV and IR radiations, emits low heat.
- 0-10V dimming standard, motion sensor, photocell, emergency battery optional.
- UL/cUL/UKCA/FCC/CE/RoHS approval.
- 5 years warranty.



SPECIFICATION

Item NO.	Watt	Lumen	Dimension	CCT	Voltage	Beam Angle	CRI	PF
RMS-H251645	45W	6750LM	223*195.5*183mm	3K-4K-5K-6K-6.5K	AC120~277V AC120~347V AC277~480V	180°	>80	>0.9
RMS-H251670	70W	11000LM	360*257*187mm	3K-4K-5K-6K-6.5K	AC120~277V AC120~347V AC277~480V	180°	>80	>0.9
RMS-H251695	95W	14300LM	360*257*187mm	3K-4K-5K-6K-6.5K	AC120~277V AC120~347V AC277~480V	180°	>80	>0.9

Remarks: All lumen specs are based on 5000K

OFFERING
4 WATTAGE AND 3 CCT SELECTABLE
MEETS YOUR VARIOUS NEEDS!

WATTAGE SELECTABLE



100% 80% 60% 40%

CCT SELECTABLE



3000K 4000K 5000K

OPTIONAL ACCESSORIES

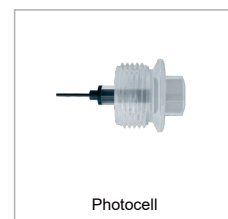
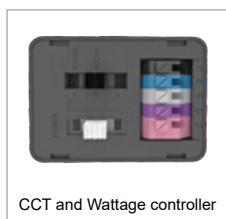

RMS-L2303

Mini LED Wall Pack Series



PRODUCT FEATURES

- Light Efficiency: 120LPW.
- High-transmittance and anti-UV Polycarbonate lens.
- Come with an integrated photocell as standard.
- Standard with 0-10V dimming allowing for 0% to 100% dimming.
- Excellent thermal management design.
- Aluminum housing with polyester powder coat finish.
- IP65/IK08 rating for outdoor usage.
- Energy savings, no UV and IR radiation, emits low heat.
- UL/cUL/UKCA/FCC/CE/RoHS approval.
- 5 years warranty.



SPECIFICATION

Item NO.	Watt	Lumen	Dimension	CCT	Voltage	Beam Angle	CRI	PF
RMS-L230330	30W	3600LM±10%	210*140*79mm	3K-4K-5K-6K-6.5K	AC120V AC100-277V	120°	>80	>0.9

Remarks: All lumen specs are based on 5000K

DUSK TO DAWN
BUILT-IN DUSK
TO DAWN PHOTOCELL



Auto Off at Dawn





Auto On at Dusk



APPLICATION

Mini Wall Pack Light's robust design ensures durability in harsh outdoor environments. Suitable for Site Lighting, Security Lighting, Pathways, Entrances, Perimeters, and other applications.

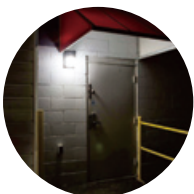

RMS-L2101

LED Vapor-Proof Jelly Jar Fixture Series



Photocell Sensor



PRODUCT FEATURES

- Light Efficiency up to 110LPW.
- LED integrated design for quick installation, reduce maintenance.
- IP65 vapor tight design keeps out dust, moisture and water.
- Rugged cast aluminum housing with powder coated.
- Stainless steel wire guard, shatter, impact and corrosion resistant.
- Polycarbonate frosted diffuser provides you glare-free light.
- Available in ceiling and wall mounting, 0~90° lighting angle adjustable.
- Suitable to install on most existing universal junction box.
- Optional junction box with four 3/4" conduit entries for easy wiring.
- Optional dusk to dawn with integrated photocell.
- UL/cUL/ETL/cETL/UKCA/FCC/CE/RoHS approval.
- 5 years warranty.

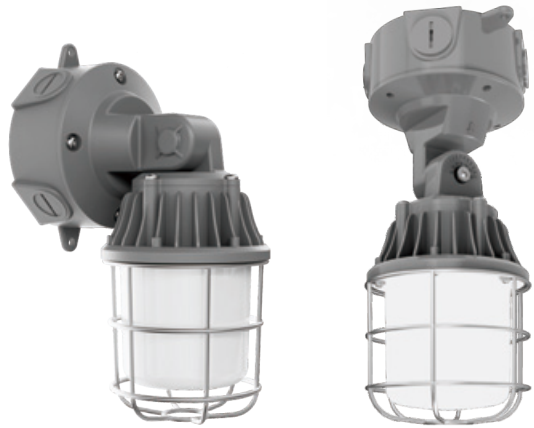

SPECIFICATION

Item NO.	Watt	Lumen	Dimension	CCT	Voltage	Beam Angle	CRI	PF
RMS-L210120	20W	2200LM±10%	Ø106.5*215.35mm Ø106.5*257mm	3K-4K-5K-6K-6.5K	AC100~277V	360°	>80	>0.9

Remarks: All lumen specs are based on 5000K

DUSK TO DAWN
BUILT-IN DUSK
TO DAWN PHOTOCELL



Auto Off at Dawn

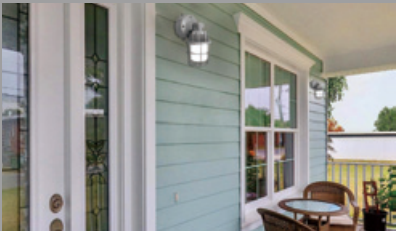



Auto On at Dusk



APPLICATION

Romanso LED Vaporproof Jelly Jars are designed to replace 150-watt incandescent and 70-watt MH bulb with highquality, longlasting illumination over doorways, scaffolding, construction sites, fire hydrants and emergency call stations.

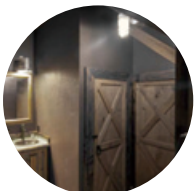

RMS-L2414 LED Flood Light Series



PRODUCT FEATURES

- High lumen effect can up to 150LPW.
- 120° light distribution can reach 170LPW.
- Selectable Power&CCT function help to less your SKUs.
- Optics of 30°/45°/60°/90°/120°/40°130°/T2M/T3M/T4S/T2 available on request.
- 45° asymmetrical light distribution for better light directionality in applications of tennis courts, basketball courts, volleyball courts.
- Designed with buckle with tempered glass but no screws in the surface for easy installation and maintenance.
- Corrosion resistant polyester powder coat finish.
- 0-10V dimmable standard, Photocell sensor, optional.
- Multiple mounting brackets and accessories optional.
- IP66 rating against dust, waterproof, weather for outdoor usage.
- ETL/cETL/UKCA/FCC/CE/RoHS Certificate.
- 5 years warranty.



SPECIFICATION

Item NO.	Watt	Lumen	Dimension	CCT	Voltage	Beam Angle	CRI	PF
RMS-L241450	50W	6500LM	242*263.5*53.6mm	3K-4K-5K-6K-6.5K	AC100-277V AC120-347V AC277-480V	30°/45°/60°/90°/ 120°/40°130°/ T2M/T3M/T4S/T2	>80	>0.9
RMS-L241475	75W	13000LM	242*263.5*53.6mm	3K-4K-5K-6K-6.5K	AC100-277V AC120-347V AC277-480V	30°/45°/60°/90°/ 120°/40°130°/ T2M/T3M/T4S/T2	>80	>0.9
RMS-L2414100	100W	13000LM	242*309.5*53.6mm	3K-4K-5K-6K-6.5K	AC100-277V AC120-347V AC277-480V	30°/45°/60°/90°/ 120°/40°130°/ T2M/T3M/T4S/T2	>80	>0.9
RMS-L2414150	150W	19500LM	242*309.5*53.6mm	3K-4K-5K-6K-6.5K	AC100-277V AC120-347V AC277-480V	30°/45°/60°/90°/ 120°/40°130°/ T2M/T3M/T4S/T2	>80	>0.9
RMS-L2414200	200W	26000LM	298*368.6*54mm	3K-4K-5K-6K-6.5K	AC100-277V AC120-347V AC277-480V	30°/45°/60°/90°/ 120°/40°130°/ T2M/T3M/T4S/T2	>80	>0.9
RMS-L2414240	240W	31200LM	298*368.6*54mm	3K-4K-5K-6K-6.5K	AC100-277V AC120-347V AC277-480V	30°/45°/60°/90°/ 120°/40°130°/ T2M/T3M/T4S/T2	>80	>0.9
RMS-L2414300	300W	39000LM	422*446*64mm	3K-4K-5K-6K-6.5K	AC100-277V AC120-347V AC277-480V	30°/45°/60°/90°/ 120°/40°130°/ T2M/T3M/T4S/T2	>80	>0.9
RMS-L2414400	400W	58500LM	422*446*64mm	3K-4K-5K-6K-6.5K	AC100-277V AC120-347V AC277-480V	30°/45°/60°/90°/ 120°/40°130°/ T2M/T3M/T4S/T2	>80	>0.9

Remarks: All lumen specs are based on 5000K

OFFERING
3 WATTAGE AND 3 CCT SELECTABLE
MEETS YOUR VARIOUS NEEDS!

WATTAGE SELECTABLE

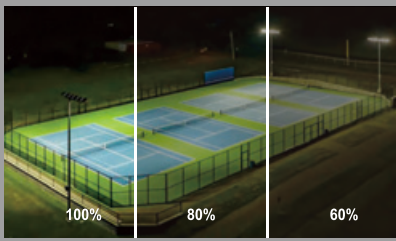

100% 80% 60%

CCT SELECTABLE



3000K 4000K 5000K

PHOTOMETRICS

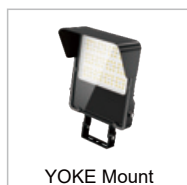

RMS-H2502

LED Explosion-proof Fixture Series



PRODUCT FEATURES

- Light Efficiency: 160-170lm/W.
- High-transmittance tempered glass with anti-UV Polycarbonate lens.
- 60°/90°/120° beam angle optional.
- Robust cast aluminum housing with low copper content with stands harsh or hostile environments.
- Precise number of fins dissipate maximum amount of heat.
- IP65/IK08 rating for outdoor usage.
- Energy savings, no UV and IR radiations, emits low heat.
- 0-10V/PWM/Rx 3-in-1 Dimming optional.
- Operating Temperature Range: -40°C - + 65°C.
- 5 years warranty.



SPECIFICATION

Item NO.	Watt	Lumen	Dimension	CCT	Voltage	Beam Angle	CRI	PF
RMS-H250260	60W	10500LM	Ø329*258mm	3K-4K-5K-6K-6.5K	AC120~277V AC347~480V	60°/90°/120°	>80	>0.9
RMS-H250270	70W	11500LM	Ø329*258mm	3K-4K-5K-6K-6.5K	AC120~277V AC347~480V	60°/90°/120°	>80	>0.9
RMS-H250280	80W	12500LM	Ø329*258mm	3K-4K-5K-6K-6.5K	AC120~277V AC347~480V	60°/90°/120°	>80	>0.9
RMS-H250290	90W	14000LM	Ø329*258mm	3K-4K-5K-6K-6.5K	AC120~277V AC347~480V	60°/90°/120°	>80	>0.9
RMS-H2502100	100W	15500LM	Ø329*258mm	3K-4K-5K-6K-6.5K	AC120~277V AC347~480V	60°/90°/120°	>80	>0.9
RMS-H2502120	120W	20500LM	Ø329*258mm	3K-4K-5K-6K-6.5K	AC120~277V AC347~480V	60°/90°/120°	>80	>0.9
RMS-H2502140	140W	23500LM	Ø329*258mm	3K-4K-5K-6K-6.5K	AC120~277V AC347~480V	60°/90°/120°	>80	>0.9
RMS-H2502160	160W	26000LM	Ø329*258mm	3K-4K-5K-6K-6.5K	AC120~277V AC347~480V	60°/90°/120°	>80	>0.9
RMS-H2502180	180W	29000LM	Ø329*258mm	3K-4K-5K-6K-6.5K	AC120~277V AC347~480V	60°/90°/120°	>80	>0.9
RMS-H2502200	200W	31500LM	Ø329*258mm	3K-4K-5K-6K-6.5K	AC120~277V AC347~480V	60°/90°/120°	>80	>0.9

Remarks: All lumen specs are based on 5000K





COMPLIANCE

UL 844 Hazardous Locations
Class I Division 2, Group A, B, C, D
Class II Division 1, Group E, F, G
Class II Division 2, Group G
Class III

UL 1598 Wet Locations



MOUNTING

Trunnion Mount (default)	Ceiling mount (option)	Pendant (option)	Wall Mount (option)	Round pole mount (option)
				

RMS-H2314

LED Explosion Proof Flood Fixture Series



PRODUCT FEATURES

- Light Efficiency: 120lm/W.
- High-transmittance tempered glass with anti-UV Polycarbonate lens.
- 60°/90° beam angle optional.
- Robust cast aluminum housing with low copper content with stands harsh or hostile environments.
- IP66 waterproof rating, suitable for wet or dry locations.
- Energy savings, no UV and IR radiations, emits low heat.
- Operating Temperature Range: -40°C - + 65°C.
- 5 years warranty.



SPECIFICATION

Item NO.	Watt	Lumen	Dimension	CCT	Voltage	Beam Angle	CRI	PF
RMS-H231430	30W	3600LM	308*255*240mm	3K-4K-5K-6K-6.5K	AC100-277V	60°/90°	>80	>0.9
RMS-H231450	50W	6000LM	308*255*240mm	3K-4K-5K-6K-6.5K	AC100-277V	60°/90°	>80	>0.9
RMS-H2314100	100W	12000LM	308*255*240mm	3K-4K-5K-6K-6.5K	AC100-277V	60°/90°	>80	>0.9
RMS-H2314150	150W	28000LM	448*308*220mm	3K-4K-5K-6K-6.5K	AC100-277V	60°/90°	>80	>0.9
RMS-H2314200	200W	24000LM	448*308*220mm	3K-4K-5K-6K-6.5K	AC100-277V	60°/90°	>80	>0.9
RMS-H2314240	240W	28800LM	480*380*330mm	3K-4K-5K-6K-6.5K	AC100-277V	60°/90°	>80	>0.9
RMS-H2314300	300W	36000LM	480*380*330mm	3K-4K-5K-6K-6.5K	AC100-277V	60°/90°	>80	>0.9

Remarks: All lumen specs are based on 5000K

COMPLIANCE

- * Hazardous locations:
Zone 0, Zone 1 and Zone 2
- * Gas explosive environment:
Group IIA, IIB, IIC
- * T1-T6 temperature classification



MOUNTING

Typical applications include manufacturing plants, and certain chemical and petrochemical processing facilities, sewage treatment plants, off-shore and dockside installations, garages and storage facilities.



RMS-L2308 LED Corn Light Series



PRODUCT FEATURES

- Light Efficiency: 130LPW.
- High-transmittance and anti-UV Polycarbonate lens.
- CCT and wattages adjustable optional.
- Motion sensor optional. Standard AC100-277V, HVU 347V/480V optional.
- E26/E27/E39/EX39/E40 base optional.
- IP64 rating for indoor and outdoor usage.
- Energy savings, no UV and IR radiation, emits low heat.
- ETL/cETL/UKCA/FCC/CE/RoHS approval.
- 5 years warranty.



SPECIFICATION

Item NO.	Watt	Lumen	Base	Dimension	CCT	Voltage	Beam Angle	CRI	PF
RMS-L230827	27W	3510LM	E26/E27/E39/ EX39/E40	Ø90*193mm	3K-4K-5K-6K-6.5K	AC100-277V	360°	>80	>0.9
RMS-L230836	36W	4680LM	E26/E27/E39/ EX39/E40	Ø90*213mm	3K-4K-5K-6K-6.5K	AC100-277V	360°	>80	>0.9
RMS-L230845	45W	5850LM	E26/E27/E39/ EX39/E40	Ø90*238mm	3K-4K-5K-6K-6.5K	AC100-277V	360°	>80	>0.9
RMS-L230854	54W	7020LM	E26/E27/E39/ EX39/E40	Ø90*263mm	3K-4K-5K-6K-6.5K	AC100-277V	360°	>80	>0.9

Remarks: All lumen specs are based on 5000K

OFFERING
3 WATTAGE AND 3 CCT SELECTABLE
MEETS YOUR VARIOUS NEEDS!

WATTAGE SELECTABLE



100% 80% 60%

CCT SELECTABLE



3000K 4000K 5000K

DIMENSION[MM]

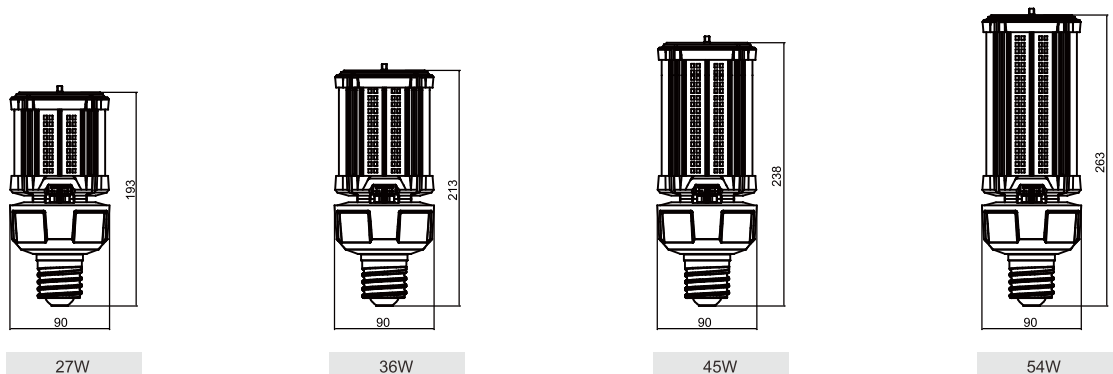

MRS-L2308 LED Corn Light Series



PRODUCT FEATURES

- Light Efficiency: 130LPW.
- High-transmittance and anti-UV Polycarbonate lens.
- CCT and wattages adjustable optional.
- Motion sensor optional. Standard AC100-277V, HVU 347V/480V optional.
- E26/E27/E39/EX39/E40 base optional.
- IP64 rating for indoor and outdoor usage.
- Energy savings, no UV and IR radiation, emits low heat.
- ETL/cETL/UKCA/FCC/CE/RoHS approval.
- 5 years warranty.



SPECIFICATION

Item NO.	Watt	Lumen	Base	Dimension	CCT	Voltage	Beam Angle	CRI	PF
RMS-L230863	63W	8190LM	E26/E27/E39/ EX39/E40	Ø90*295mm	3K-4K-5K-6K-6.5K	AC100-277V	360°	>80	>0.9
RMS-L230880	80W	10400LM	E26/E27/E39/ EX39/E40	Ø140*260mm	3K-4K-5K-6K-6.5K	AC100-277V	360°	>80	>0.9
RMS-L2308100	100W	13000LM	E26/E27/E39/ EX39/E40	Ø140*285mm	3K-4K-5K-6K-6.5K	AC100-277V	360°	>70	>0.9
RMS-L2308120	120W	15600LM	E26/E27/E39/ EX39/E40	Ø140*310mm	3K-4K-5K-6K-6.5K	AC100-277V	360°	>70	>0.9

Remarks: All lumen specs are based on 5000K

OFFERING
3 WATTAGE AND 3 CCT SELECTABLE
MEETS YOUR VARIOUS NEEDS!

WATTAGE SELECTABLE



100% 80% 60%

CCT SELECTABLE



3000K 4000K 5000K

DIMENSION[MM]

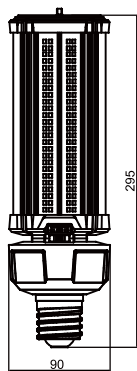

63W

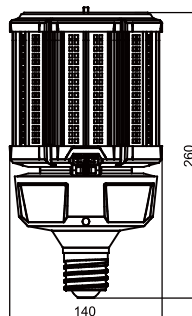

80W

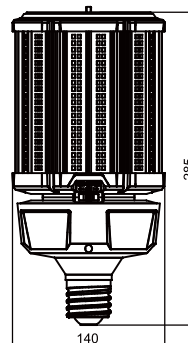

100W

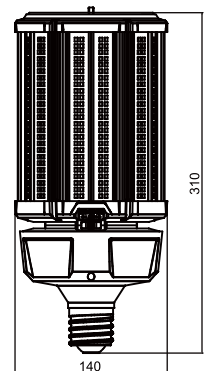

120W

RMS-K8 LED Corn Light Series



PRODUCT FEATURES

- Light Efficiency: 130LPW.
- High-transmittance and anti-UV Polycarbonate lens.
- Standard AC100-277V, HVU 347V/480V optional.
- E26/E27 base optional.
- IP64 rating for indoor and outdoor usage.
- Energy savings, no UV and IR radiation, emits low heat.
- ETL/cETL/UKCA/FCC/CE/RoHS approval.
- 5 years warranty.



SPECIFICATION

Item NO.	Watt	Lumen	Base	Dimension	CCT	Voltage	Beam Angle	CRI	PF
RMS-360D-E-K8-8W	8W	1040LM	E26/E27	Ø55*100mm	3K-4K-5K-6K-6.5K	AC100-277V	360°	>80	>0.9
RMS-360D-E-K8-12W	12W	1560LM	E26/E27	Ø64*157mm	3K-4K-5K-6K-6.5K	AC100-277V	360°	>80	>0.9
RMS-360D-E-K8-16W	16W	2080LM	E26/E27	Ø64*167mm	3K-4K-5K-6K-6.5K	AC100-277V	360°	>80	>0.9
RMS-360D-E-K8-20W	20W	2600LM	E26/E27	Ø64*187mm	3K-4K-5K-6K-6.5K	AC100-277V	360°	>80	>0.9
RMS-360D-E-K8-24W	24W	3120LM	E26/E27	Ø64*207mm	3K-4K-5K-6K-6.5K	AC100-277V	360°	>80	>0.9

Remarks: All lumen specs are based on 5000K

DIMENSION[MM]

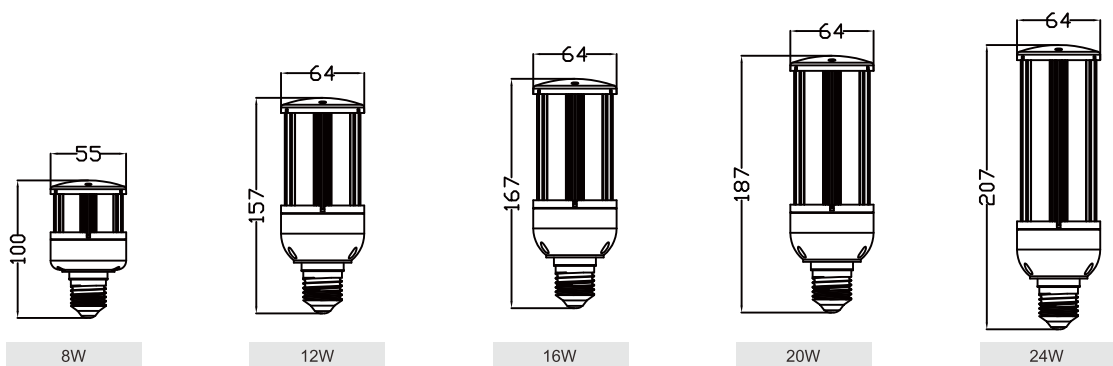



ROMANSO[®]

SHENZHEN ROMANSO ELECTRONIC CO., LTD.

Add: 3F, No.1 Building, Guanghui industrial park, Tianbao road, Yingrenshi community,
Shiyan town, Baoan district, Shenzhen

Tel: +86-0755-29197500

E-mail: romanso@romanso.com | Website: www.romanso.com

ROMANSO ELECTRONIC CO., LTD.

Add: Rm 20 Unit B3, 07/FL Tuen Mun, IND CTR NO 2 San Ping Circuit, Tuen Mun,
Hong Kong

Tel: +852 84001207

TW LIGHTS CO., LTD.

Add: Ou Ta Pung, Roka Kaoh, Kong Pisei, Kampong Speu, Cambodia

Tel: +855 98770307



Ver. 2025/10